

User Guide



MOTOROLA **BRUTE™** i680

www.nextel.com

©2009 Sprint. SPRINT and the NEXTEL name and logo are trademarks of Sprint. Other marks are the property of their respective owners.

2/2/10

NEXTEL |[®]

Motorola, Inc.
Consumer Advocacy Office
600 North US Hwy 45
Libertyville, IL 60048

www.hellomoto.com

Note: Do not ship your phone to the above address. If you need to return your phone for repairs, replacement or warranty service, please contact the Motorola Customer Support Center at:

1-800-453-0920 (United States)

1-877-483-2840 (TTY/TDD United States for hearing impaired)

Product Support:

www.motorola.com/support

Certain mobile phone features are dependent on the capabilities and settings of your service provider's network. Additionally, certain features may not be activated by your service provider, and/or the provider's network settings may limit the feature's functionality. Always contact your service provider about feature availability and functionality. All features, functionality, and other product specifications, as well as the information contained in this user's guide are based upon the latest available information and are believed to be accurate at the time of printing. Motorola reserves the right to change or modify any information or specifications without notice or obligation.

Important: Important Privacy Message: Sprint's policies often do not apply to third-party applications. Third-party applications may access your personal information or require Sprint to disclose your customer information to the third-party application provider. To find out how a third-party application will collect, access, use, or disclose your personal information, check the application provider's policies, which can usually be found on their website. If you aren't comfortable with the third-party application's policies, don't use the application.

Manual number: NNTN7794C

DECLARATION OF CONFORMITY

Per FCC CFR 47 Part 2 Section 2.1077(a)



Responsible Party Name: Motorola, Inc.

Address: 8000 West Sunrise Boulevard
Plantation, FL 33322 USA

Phone Number: 1 (800) 453-0920

Hereby declares that the product:

Product Name: i680

Model Number: H85XAH6JR5AN

FCC-ID: IHDT56KD1

Conforms to the following regulations:

FCC Part 15, subpart B, section 15.107(a), 15.107(d) and section
15.109(a)

FCC Notice to Users

The following statement applies to all products that have received FCC approval. Applicable products bear the FCC logo, and/or an FCC ID in the format FCC-ID: IHDT56KD1 on the product label.

Motorola has not approved any changes or modifications to this device by the user. Any changes or modifications could void the user's authority to operate the equipment. See 47 CFR Sec. 15.21.

Class B Digital Device

As a personal computer peripheral, this device complies with part 15 of the FCC Rules. Operation is subject to the following two conditions: (1) This device may not cause harmful interference, and (2) this device must accept any interference received, including interference that may cause undesired operation. See 47 CFR Sec. 15.19(3).

Note: This equipment has been tested and found to comply with the limits for a Class B digital device, pursuant to part 15 of the FCC Rules. These limits are designed to provide reasonable protection against harmful interference in a residential installation. This equipment generates, uses and can radiate radio frequency energy and, if not installed and used in accordance with the instructions, may cause harmful interference to radio communications. However, there is no guarantee that interference will not occur in a particular installation.

If this equipment does cause harmful interference to radio or television reception, which can be determined by turning the equipment off and on, the user is encouraged to try to correct the interference by one or more of the following measures:

- Reorient or relocate the receiving antenna.
- Increase the separation between the equipment and receiver.
- Connect the equipment into an outlet on a circuit different from that to which the receiver is connected.
- Consult the dealer or an experienced radio/TV technician for help.

Table of Contents

Introduction	i	Nextel Direct Connect	28
Use and Care	ii	Group Connect	30
1. Setting Up Service	1	Nextel Direct Send	34
Setting Up Your Phone	1	Talkgroups	39
Activating Your Phone	2	Call Alerts	41
Setting Up Voicemail	2	Direct Talk	43
Enabling Security	3	4. Service Features: The Basics	47
Account Passwords	3	Message Center	47
Getting Help	4	Receiving Messages	48
2. Phone Basics	5	Voicemail	49
Your Phone	5	Multimedia Messages (MMS)	50
Getting Started With Your Phone	7	Text Messaging (SMS)	59
Navigating Through Menus and Options	14	Caller ID Blocking	59
Displaying Your Numbers	16	Call Waiting	60
Entering Text	16	Making a Second Call	61
Accessories	20	Making a Three-Way Call	61
3. Making and Answering Calls	21	Call Forwarding	61
Types of Calls	21	Making International Calls	64
Phone Calls	22	Special Dialing Codes	64
		Nextel Phone Services	65

5. Data Services	66	Prepending a Number From Recent Calls	96
Wireless Data Services	66	8. Contacts	97
Downloading Content	68	About Contacts	97
6. Settings	69	Creating Contacts Entries	98
Sound Settings	69	Viewing Contacts	100
Display Settings	73	Adding a Number to an Entry	101
Messaging Settings	75	Editing Entries	101
Airplane Mode	77	Deleting Entries	102
Setting One Touch Direct Connect	78	Assigning Speed Dial Numbers	102
Headset Options	78	Selecting a Ringer Type for an Entry	103
Profiles	78	Assigning a Picture to an Entry	103
Phone Setup Options	82	9. Tools	104
Personalize	84	Datebook	104
DC/GC Options Menu	88	My Info	109
Security Settings	89	Java Applications	110
7. Recent Calls	92	Digital Rights Management (DRM)	111
About Recent Calls	92	GPS Enabled	113
Viewing Recent Calls	94	Memo Feature	117
Recent Calls Options	94	Voice Records	118
Saving Items From Recent Calls	95	Call Timers	120
Deleting Items From Recent Calls	95		

10. microSD Card	121
Using a microSD Card With Your Phone	121
microSD Settings	123
microSD Folders	124
Connecting Your Phone to Your Computer	125
11. Camera	126
Taking Pictures	126
Camera Options	127
Recording Videos	128
Storing Pictures and Videos	130
12. Bluetooth	132
Turning Bluetooth On and Off	132
Bluetooth Menu	133
Connecting Bluetooth Devices	133
Sending Items via Bluetooth	135
13. Multimedia	138
Media Center	138
My Music	142
My Images	150
My Videos	151

S1. Important Safety Information	154
General Precautions	154
Maintaining Safe Use of and Access to Your Phone	155
Battery Use and Safety	158
Using Your Phone With a Hearing Aid Device	161
Caring for the Environment by Recycling	163
Export Law Assurances	163
California Perchlorate Label	163
Radio Frequency (RF) Energy	164
Owner's Record	168
Patent and Trademark Information	168
Software Copyright Notice	169
Privacy and Data Security	170
Smart Practices While Driving	170
S2. Manufacturer's Warranty	172
Motorola Limited Warranty for the United States and Canada	172
Service and Repairs	176
Index	177

Introduction

This **User Guide** introduces you to your wireless service and all the features of your new phone.

Throughout this guide, you'll find tips that highlight special shortcuts and timely reminders to help you make the most of your new phone and service. The Table of Contents and Index will also help you quickly locate specific information.

You'll get the most out of your phone if you read each section. However, if you'd like to get right to a specific feature, simply locate that section in the Table of Contents and go directly to that page. Follow the instructions in that section, and you'll be ready to use your phone in no time.

Note: Because of updates in phone software, this printed guide may not be the most current version for your phone. Visit www.nextel.com and sign in to access the most recent version of the user guide.

WARNING: Please refer to the **Important Safety Information** section on page 154 to learn about information that will help you safely use your phone. Failure to read and follow the Important Safety Information in this phone guide may result in serious bodily injury, death, or property damage.

Use and Care

To care for your Motorola phone, keep it away from:



liquids of any kind

The MOTOROLA BRUTE™ i680 is designed to withstand being exposed to blowing rain when the battery door is attached properly, and the headset jack and microUSB connector are properly covered and sealed. Exposure to other liquids should be avoided, especially corrosive liquids.



cleaning solutions

To clean your phone, use only a dry soft cloth. Don't use alcohol or other cleaning solutions.



extreme heat or cold

Don't expose your phone to extreme high or low temperatures outside of -10°C/14°F or above 45°C/113°F.



microwaves

Don't try to dry your phone in a microwave oven.

1. Setting Up Service

- ◆ Setting Up Your Phone (page 1)
- ◆ Activating Your Phone (page 2)
- ◆ Setting Up Voicemail (page 2)
- ◆ Enabling Security (page 3)
- ◆ Account Passwords (page 3)
- ◆ Getting Help (page 4)

Your Phone's Navigation Pad

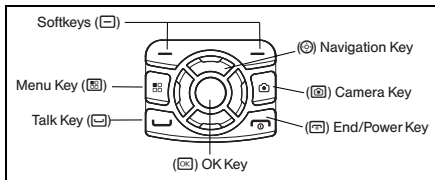

Setting Up Your Phone

1. Make sure your SIM card is in place.
 - See “Your SIM Card” on page 8.
2. Install the battery.
 - See “Installing the Battery” on page 10.
3. Press and hold the **End/Power Key** (⏻) for two seconds to turn the phone on.
 - If your phone is activated, it will turn on, search for service, and enter standby mode.
 - If your phone's SIM PIN is set, you may be prompted to enter your SIM PIN code when you turn on your phone. Enter the four-digit number and press the left softkey (the top left key below the display screen) to select **Ok**. Press **Yes** (left softkey) to allow phone transmissions as prompted. (See “SIM Card Security” on page 89 for more information.)
 - If your phone is not yet activated, see “Activating Your Phone” on page 2 for more information.

Note: You may see a prompt to update your browser information. Press **Ok** (left softkey) to complete the task.

4. Make your first call.
 - Use your keypad to enter a phone number.
 - Press the **Talk** key (☎).

Note: Your phone's battery should have enough charge for your phone to turn on and find a signal, set up your voicemail, and make a call. You should fully charge your battery as soon as possible. See "Charging the Battery" on page 11 for details.

Activating Your Phone

- If you purchased your phone at a Nextel Store, it is probably activated and ready to use.
- If your phone is not activated, please call Nextel Customer Service at 1-800-639-6111 from any other phone.

Tip: You must be in an area covered by the Nextel National Network when you first power up your phone.

- When you power up your phone the first time, it performs a series of security checks. For example, it verifies the phone is Nextel-approved and the correct SIM card is installed. If you don't pass the security checks, your phone displays messages and screen

prompts showing what to do next. If you still encounter security messages, call Nextel Customer Service at 1-800-639-6111 from any other phone.

Setting Up Voicemail

All unanswered calls to your phone are automatically transferred to your voicemail, even if your phone is in use or turned off. Therefore, it is recommended that you set up your voicemail and personal greeting as soon as your phone is activated.



1. Using your MOTOROLA BRUTE, call your wireless phone number.
2. Follow the system prompts to:
 - Create your passcode.
 - Record your name announcement.
 - Record your greeting.

Note: **Voicemail Passcode:** It is strongly recommended that you create a passcode when setting up your voicemail to protect against unauthorized access. Without a passcode, anyone who has access to your phone is able to access your voicemail messages.

For more information about using your voicemail, (see “Voicemail” on page 49.)

Enabling Security

You must enable security the first time you power on your phone or within ten days of first activating your phone.

1. Press and hold  for two seconds to power on your phone.
2. Press **Ok** (right softkey).
3. You are prompted to enable security. Press **Yes** (right softkey). A series of screens followed by the default homepage displays.
4. Press  to return to standby mode.

Account Passwords

With Nextel service, you enjoy unlimited access to your personal account information and voicemail account. To ensure that no one else has access to your information, you need to create passwords to protect your privacy.

Account Username and Password

If you are the account owner, you will create an account username and password when you sign on to www.nextel.com. (Click **Need to register for access?** to get started.) If you are not the account owner (if someone else receives the bill for your service), you can get a sub-account password at www.nextel.com.

Note: When you go to www.nextel.com, you will be redirected to www.sprint.com by default. Follow the sign in instructions above to access your Nextel account.

Voicemail Password

You will create your voicemail password (or passcode) when you set up your voicemail. See “Setting Up Voicemail” on page 2 for more information on your voicemail password.

Getting Help

Managing Your Account

Online: www.nextel.com

- Access your account information.
- Check your minutes used (depending on your service plan).
- View and pay your bill.
- Enroll for online billing and automatic payment.
- Purchase accessories.
- Shop for the latest phones.
- View available service plans and options.

From Your MOTOROLA BRUTE

- Press ***4☎** to check minute usage and account balance.
- Press ***3☎** to make a payment.

From Any Other Phone

- Nextel Customer Service: **1-800-639-6111**.
- Business Customer Service: **1-877-639-8351**.

Operator Services

Operator Services provides assistance when you place collect calls or when you place calls billed to a local telephone calling card or third party.

- ▶ Press **0☎**.

For more information or to see the latest in products and services, visit us online at www.nextel.com.

2. Phone Basics

- ◆ Your Phone (page 5)
- ◆ Getting Started With Your Phone (page 7)
- ◆ Navigating Through Menus and Options (page 14)
- ◆ Displaying Your Numbers (page 16)
- ◆ Entering Text (page 16)
- ◆ Accessories (page 20)

Your Phone

Open View



Closed View

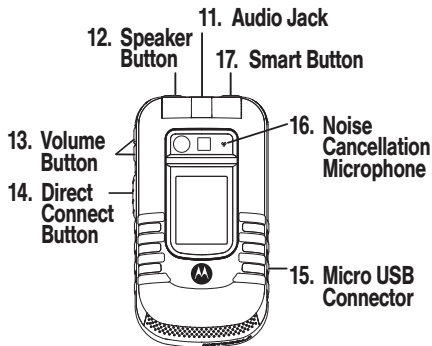

Key Functions

1. **Left Softkey** (☐) lets you select softkey actions or menu items corresponding to the bottom left line on the display screen.
2. **Menu Key** (☐) lets you access the phone's menu from standby mode and allows you to access context-sensitive menus from other screens.
3. **Talk Key** (☎) allows you to place or receive calls, answer Call Waiting, or use Three-Way Calling.
4. **Navigation Key** scrolls through the phone's menu options and acts as a shortcut key from standby mode.
5. **Back Key** (⌫) deletes characters in text entry mode. When using the Web, it allows you to return to the previous page.
6. **Space Key** (⌵) enters a space in text entry mode.
7. **End/Power Key** (☎) allows you to end calls, return to standby mode, or turn the phone on or off.
8. **Camera Key** (📷) allows you to activate the phone's camera.
9. **OK Key** (OK) selects the highlighted choice when navigating through a menu.
10. **Right Softkey** (☐) lets you select softkey actions corresponding to the bottom right line on the display screen.
11. **Audio Jack** allows you to connect your headphones to your phone.

12. **Speaker Button** (☎) lets you place or receive calls in speaker mode. In standby mode, pressing the speaker button turns Direct Connect speaker mode on and off.
13. **Volume Button** allows you to adjust the ringer volume in standby mode, the voice or speaker volume during a call, and the speaker volume while using the music player or other applications.
14. **Direct Connect (DC) Button** allows you to use Nextel Direct Connect[®]. (See page 28.)
15. **Micro USB Connector** allows you to connect your charger or other accessories to your phone.
16. **Noise Cancellation Microphone** eliminates ambient noise to provide improved, clearer call quality.
17. **Smart Button** (▣) anticipates the next action you are likely to perform. For example, when you highlight a menu item, you can press the Smart Button to select it. You can also use the Smart Button to end calls when your phone is closed.

Note: The use of wireless phones while driving may cause distraction. Discontinue a call if you can't concentrate on driving. Additionally, the use of wireless devices and their accessories may be prohibited or restricted in certain areas. Always obey the laws and regulations on the use of these products.

Getting Started With Your Phone

To start using your MOTOROLA BRUTE:

- Make sure your SIM card is in place.
- Charge the battery.
- Turn on your phone.

After you've completed these items, you are ready to begin using your new phone.

WARNING: Do not cover the Noise Cancellation Microphone while making a phone call. If covered the sound quality of your phone call will be affected.

Note: The Noise Cancellation Microphone does not function when you are on the speaker phone or making a Direct Connect call.

Your SIM Card

Locating the SIM Card

Your SIM (Subscriber Identity Module) card is a small card inserted into the SIM card holder within your phone below the battery.

If no SIM card came with your phone, contact Nextel Customer Service at 1-800-639-6111.

Most users will never need to remove or insert the SIM card. However, if it becomes necessary, follow the instructions in “Removing and Inserting the SIM Card” on page 8.

Important: The SIM card is designed for optimal Contacts storage and feature use. For Nextel SIM card compatibility information, visit www.nextel.com/sim.

In some cases, Contacts and Groups may not be accessible if you move your SIM card to another phone. Contacts and Groups created with your MOTOROLA BRUTE may not be readable by an older iDEN SIM-based phone.

Removing and Inserting the SIM Card

Important: To avoid losing information stored in your SIM card, do not remove it from your phone unless absolutely necessary.

To remove your SIM card:

1. With your phone powered off, turn the release tab counter-clockwise to release the battery cover, and then remove the battery cover from the back of the phone.
2. Remove the battery, and then use your thumbs to carefully slide the SIM card out from under the edge.

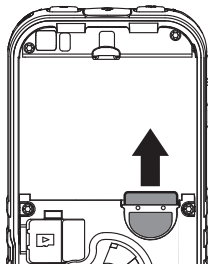

Note: Protect your SIM card as you would any delicate object. Store it carefully.

To insert your SIM card:

1. With your phone powered off, turn the release tab counter-clockwise to release the battery cover, and then remove the battery cover from the back of the phone.
2. Remove the battery, and then use your thumbs to carefully slide the SIM card into your phone until it lies flat in the SIM card holder.

Important: Do not touch the gold-colored areas of your SIM card.

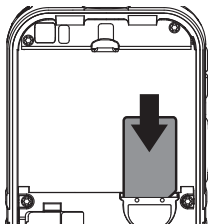

Battery and Charger

WARNING: Use only Nextel-approved or Motorola-approved batteries and chargers with your phone. The failure to use a Nextel-approved or Motorola-approved battery and charger may increase the risk that your phone will overheat, catch fire, or explode, resulting in serious bodily injury, death, or property damage.

Important: For information on battery safety, see "Battery Use and Safety" on page 158.

Nextel-approved and Motorola-approved batteries and accessories can be found at Sprint Stores or through Motorola. You may order online at www.nextel.com or by calling 1-866-866-7509.

Your phone's Lithium Ion (Li-Ion) battery allows you to recharge it before it is fully drained.

When the battery reaches 5% of its capacity, your phone makes a sound and displays a message. When there are approximately two minutes of talk time left, the phone sounds an audible alert and then turns off.

Note: Long backlight settings, searching for service, vibrate mode, browser use, and other variables may reduce the battery's talk and standby times.

Tip: Watch your phone's battery level indicator and charge the battery before it runs out of power.

Installing the Battery

1. Press down on the battery door latch, and with a coin, turn it counter-clockwise to the unlocked position.

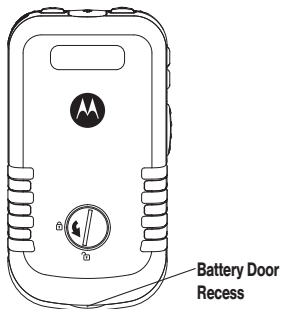

WARNING: Do not use a sharp object to unlock the battery door as it may damage the lock.

2. Place the tip of your finger in the battery door recess, and lift the battery door to remove it from the phone.

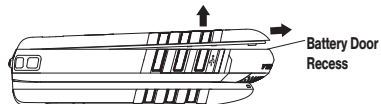

3. Insert the battery into the opening, making sure the connectors align. Gently press down to secure the battery.

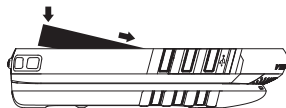

4. Replace the battery cover and firmly press it down into place to ensure a proper watertight seal. With a coin, turn the battery door latch clockwise to the locked position.

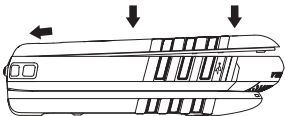

WARNING: If the battery door is not properly installed, your phone will not have a watertight seal. If the phone comes into contact with blowing rain, damage will occur.

Removing the Battery

1. Make sure the power is off so that you don't lose any stored numbers or messages.
2. Remove the battery cover and position your fingernail on the top end of the battery to remove it.

WARNING: Do not handle a damaged or leaking Li-Ion battery as you can be burned.

Charging the Battery

Charge your battery as soon as possible so you can begin using your phone.

Always use a Nextel-approved or Motorola-approved desktop charger, travel charger, or vehicle power adapter to charge your battery.

Using the Phone Charger

- ▶ Plug the flat end of the charger into the phone's micro USB connector and the other end into an electrical outlet.

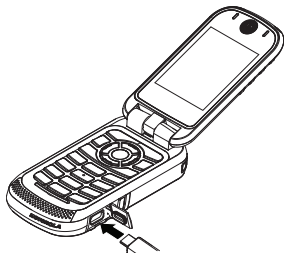

With the approved Li-Ion battery, you can recharge the battery before it becomes completely run down.

Water Resistance

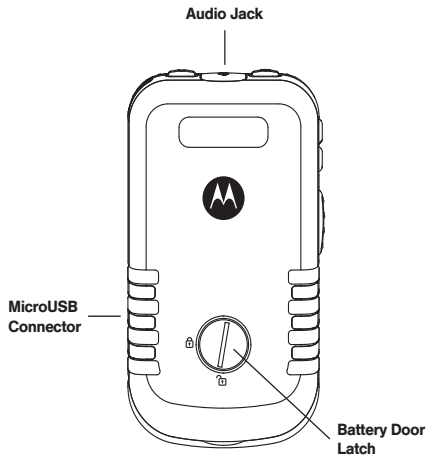

Your phone is designed to withstand being exposed to blowing rain. In order for your phone to be watertight, the battery door must be properly attached and locked,

and the audio jack and microUSB port must be properly sealed.

WARNING: Exposing your phone to water outside of these limits, or not using the precautions stated, can result in water damage.

Turning Your Phone On and Off

Turning Your Phone On

- ▶ Press and hold  for approximately two seconds.

As your phone connects to the network, you see a connecting message. Your phone may require you to enter identifying information to use it or to access specific features.

Note: If your phone's SIM PIN is set, you will be prompted to enter your SIM PIN code when you turn on your phone. Enter the four-digit number and press **Ok** (left softkey). Press **Yes** (left softkey) to allow phone transmissions as prompted.

Turning Your Phone Off

- ▶ Press and hold  for two seconds until you see the powering down animation on the display screen.

Your screen remains blank while your phone is off (unless the battery is charging).

Viewing Status Information

Your phone's display screen provides information about your phone's status and options. This list identifies the symbols you'll see on your phone's display screen:



Battery Strength — A fuller battery indicates a greater charge. The “plug” icon (bottom rows) indicates the phone is charging.



Signal Strength — More bars next to the antenna indicate a stronger signal.



No Service — Your phone is without service. You cannot make or receive any type of call.



Phone In Use — Your phone is active on a phone call.



Direct Connect In Use — Your phone is active on a Direct Connect call.



Group In Use — Your phone is active on a Group Connect call.



Direct Talk — Your phone is off network and set to Direct Talk mode.



Talkgroup In Use — Your phone is active on a Talkgroup call.



Bluetooth In Use — Your phone is using Bluetooth. If this icon is blinking, your phone is in discoverable mode. If this icon is static, a Bluetooth connection is active.



Active Phone Line — 1 indicates phone line 1 is ready to make calls; 2 indicates phone line 2 is ready to make calls.



Call Forward — Your phone is set to forward calls. See “Call Forwarding” on page 61.



Ringer Off — Your phone is set to not ring. See “Vibrate All” on page 71.





Speaker Off — Direct Connect sound is set to come through the earpiece rather than through the speaker.



Messages — You have one or more messages. See “Message Center” on page 47.



Text Input — You are using one of the phone’s text entry methods. See “Selecting a Text Input Mode” on page 16.



Internet — You are ready to browse the Internet or are browsing the Internet using a secure connection. See “5. Data Services” on page 66.



Transmitters — Your phone is set not to receive calls and other transmissions. See “Airplane Mode” on page 77.



TTY — You are ready to use your phone to make calls using a TTY (text telephone) device. See “Telecommunications Relay Service” on page 64.



Hearing Aid — Your phone is set for use with a hearing aid and is active on a phone call. See “Using Your Phone With a Hearing Aid Device” on page 161.



Voice Record — You have one or more voice records stored. See “Voice Records” on page 118.

Navigating Through Menus and Options

- ▶ Press to access the main menu, and then use the navigation key to scroll through menu items.

To navigate through a list-type menu, simply press your navigation key up or down. The scroll bar at the right of the menu keeps track of your position in the menu at all times.

Many features provide context-sensitive menus that let you access related features and actions. This icon appears onscreen any time a context-sensitive menu is available. Press to access the menu.

Selecting Menu Items

As you navigate through the menu, menu options are highlighted. Select an item by highlighting it and pressing **OK**.

For example, to view your text messages:

1. Press **Menu** to access the main menu.
2. Select **Messages** by highlighting **Messages** and pressing **OK**.
3. Select **Inbox** by highlighting it and pressing **OK**. (If you have any MMS messages, they are displayed.)

Note: For the purposes of this guide, the above steps condense into “Press **Menu** > **Messages** > **Inbox**.”

Backing Up Within a Menu

To go to the previous menu:

- ▶ Press **Back** (right softkey).

To return to standby mode:

- ▶ Press **Home**.

Shortcuts and Personalized Keys

In standby mode, your phone gives you ways to quickly access features you use frequently:

- Use the **Shortcuts** feature (page 82) to quickly access most menu options by pressing a number on your keypad or saying the voice name of the shortcut.
- Use the **Personalize** feature (page 84) to assign main menu items to the navigation keys, softkeys and **OK**, reorder the main menu, and set a main menu item to appear when you turn on your phone.

Help

Your phone contains an in-device help program to help you understand complicated or seldom used features. When you access a feature, **Help** sometimes appears as a menu item or softkey. Select **Help** and read the text for a quick overview of the feature. For more information, refer to this guide.

Displaying Your Numbers

My Info lets you view your phone number, Direct Connect number, and other phone information.

- ▶ Press  > **Tools** > **My Info**.

Entering Text

Selecting a Text Input Mode

Your phone provides convenient ways to enter letters, numbers, and symbols whenever you are prompted to enter text (for example, when adding a Contacts entry or when composing text and multimedia messages).

To choose a text input mode:

1. At a screen requiring you to enter text, press  to change the text input mode.
2. Select one of the following options:
 - **Alpha** to enter text directly using the keypad.
 - **Word** to enter text using a predictive text system that reduces the number of key presses required while entering a word. (See page 16.)

- **Symbols** to enter punctuation and other symbols. (See page 18.)
- **Numeric** to enter numbers by pressing the numbers on the keypad. (See page 18.)
- **Text Input Settings** allows you to change the settings for text input mode. (See page 17.)
- **Insert** to insert Quick Notes preset messages (**Insert QNotes**) or additional multimedia elements such as pictures or audio files into a message. (See page 54.) (You can also access Quick Notes by pressing **QNotes** [left softkey] when beginning a message.)

Tip: When entering text, press and hold the  to change letter capitalization (ABC > Abc > abc).

Entering Text Using Word Text Input

Word Text Input (T9) reduces the number of keystrokes needed to enter a word by predicting complete words as you type. While you enter letters, Word mode matches your keystrokes to words in its database and displays the most commonly used matching word. You can add your own words to this database.

1. Select the **Word** text input mode.
2. Press the corresponding keys once per letter to enter a word. (For example, to enter the word “Bill,” press **2** **4** **5** **5**.) (If you make a mistake, press **Delete** [left softkey] to erase a single character. Press and hold **Delete** [left softkey] to erase an entire entry.)
3. To accept a word and insert a space, press **#**.
4. If the word that appears is not the desired word, press the navigation key up or down to change the word on the display to the next most likely word in the database. Repeat until the desired word appears.

Adding a Word to the Database

If a specific word is not displayed as an option when you are using Word, add it to the database.

1. Select the **Alpha** text input mode. (See “Selecting a Text Input Mode” on page 16.)
2. Enter the word. (See “Entering Text Using Alpha Mode” on page 17.)
3. Select the **Word** text input mode.

The word will appear as an option the next time you scroll through options during Word Text Input.

Tip: You cannot store alphanumeric combinations such as Y2K.

To change the text input settings:

1. On a text entry screen, press **Ⓜ**.
2. Select **Text Input Settings**.
3. Select your **Primary Input** and **Secondary Input** language, and whether you want **Complete Word** and **Word Predict** features to be on or off.

Entering Text Using Alpha Mode

1. Select the **Alpha** mode. (See “Selecting a Text Input Mode” on page 16.)
2. Press the corresponding keys once per letter to enter a word. (For example, to enter the word “Bill,” press **2** twice, **4** three times, **5** three times, and **5** three times again. (If you make a mistake, press **Delete** (left softkey) to erase a single character. Press and hold **Delete** (left softkey) to erase an entire entry.)

By default, the first letter of an entry is capitalized and the following letters are lower cased. After a character is entered, the cursor automatically advances to the next space after two seconds or when you enter a character on a different key.

Characters scroll in the following order:

Key	English Sequence
1	Space . ? ! , @ & ; ; " - () ' ` ~ ! % £ \$ ¥
ABC 2	A B C 2 Á Â Ã Ä Ç
DEF 3	D E F 3 É Ê Ë
GHI 4	G H I 4 Ì Í
JKL 5	J K L 5
MNO 6	M N ñ O 6 Ó Ô Õ Ö
PQRS 7	P Q R S 7 Þ
TUV 8	T U V 8 Ú Û Ü Û
WXYZ 9	W X Y Z 9
+ 0	+ - 0 * / \ [] = > < # \$
↵ #	Space Shift Caps Lock
< ✕	Back

Entering Symbols, Numbers, and Quick Notes

To enter symbols:

- ▶ Select the **Symbols** mode. (See “Selecting a Text Input Mode” on page 16.) To enter a symbol, highlight it and press .

To enter numbers:

- ▶ Select the **Numeric** mode and press the appropriate key. (See “Selecting a Text Input Mode” on page 16.)

To enter Quick Notes:

1. From a text entry screen, press **QNotes** (left softkey).
2. Select a message and press .

Tip: To add a quick note after you have already started entering a message, press > **Insert** > **Insert QNotes**, and select a message.

Note: Quick Notes preset messages make composing text messages easier by allowing you to enter quick messages, such as “Meet me at,” “Let’s get lunch,” or a customized message of your own.



Special Function Keys

Some of the phone’s keys assume different functions while in Alpha or Word mode.

Spaces

Press  to enter a space.

Capitalization

When you press and hold the  key, it acts as a three-way toggle. Press and hold  to make the next letter typed uppercase (shift), to make all subsequent letters typed uppercase (caps lock), or to go back to lowercase letters.

These icons appear:

 or  Shift is on.



 or  Caps lock is on.

When none of these icons appear, letters typed are lowercase. Scrolling up or down after typing a letter in Alpha mode changes the case of the letter (uppercase or lowercase).

Note: When creating a text message, you may not be able to make a letter uppercase by scrolling up, depending on the type of text message and the text entry mode.

Your phone automatically makes the first letter of a sentence uppercase.

Punctuation

Press  or  to insert punctuation. Continue to press the key to view the list of symbols available through that key. Pause to select a symbol.

Note: Additional punctuation symbols are available in Symbols mode.

Accessories

Your phone comes with the following accessories:

- A Li-Ion battery and charger.
- A128K SIM card.

Various accessories are available for use with your MOTOROLA BRUTE, including cases, vehicle power chargers, data cables, hands-free accessories, and more.

To order additional accessories, go to www.nextel.com or call 1-866-866-7509. You can also contact your Nextel Authorized Representative or stop by any Sprint Store. For information on Sprint Store locations, go to www.sprintstorelocator.com.

Using a Remote Direct Connect Button

If you are using a headset or other optional accessory with a remote Direct Connect button, you can use the remote Direct Connect button for phone calls, Direct Connect calls, and Group Connect calls.

For phone calls, use the remote Direct Connect button to answer calls, switch between calls, and end calls. Hold the remote Direct Connect button for less than two seconds to answer calls and switch between calls. Hold the remote Direct Connect button for more than two seconds to end calls.

For Direct Connect calls and Group Connect calls, use the remote Direct Connect button as you would the Direct Connect button on your phone.

When using a headset, the Direct Connect button on your phone works the same way as when you are not using a headset. Direct Connect and Group Connect sounds will be heard through the headset.

3. Making and Answering Calls

- ◆ Types of Calls (page 21)
- ◆ Phone Calls (page 22)
- ◆ Nextel Direct Connect (page 28)
- ◆ Group Connect (page 30)
- ◆ Nextel Direct Send (page 34)
- ◆ Talkgroups (page 39)
- ◆ Call Alerts (page 41)
- ◆ Direct Talk (page 43)

Types of Calls

With the Nextel National Network, Nextel Direct Connect, and your MOTOROLA BRUTE, you have the following traditional wireless phone and Nextel Direct Connect services available to you:



- **Digital Wireless Phone Calls** offer clear calls and other services, such as missed call notification, Three-Way Calling, speakerphone, and speed dialing (page 22).
 - **Direct Connect Calls** allow two-way radio communication with another Direct Connect user within the Nextel National Network (page 28).
 - **Group Connect Calls** allow coast-to-coast two-way radio calling to up to 20 Nextel Direct Connect customers simultaneously (page 30).
 - **Nextel Direct Send** allows you to send contact information in Direct Connect and Group Connect calls and send pictures in Direct Connect calls (page 34).
 - **Talkgroup Calls** allow two-way radio calling to up to 100 Nextel Talkgroup customers simultaneously (page 39).
- Note:* To learn more about the differences between Nextel Group Connect calls and Talkgroup calls, please see "Difference Between Group Connect and Talkgroup Calls" on page 39.
- **Nextel Direct Talk** allows for two-way radio communication "off the network" between two or

more phones equipped with this capability (page 43).

Phone Calls

Making Calls

Placing a traditional wireless phone call from your MOTOROLA BRUTE is as easy as making a call from any landline phone.

1. Make sure your phone is on.
2. Enter a phone number from standby mode and press . (If you make a mistake while dialing, press **Delete** [right softkey] to erase the numbers.)
3. Press  when you are finished.

Tip: To redial your last outgoing call, press and hold .

You can also place calls from your phone by using Voice Names (page 27), speed dialing numbers from your Contacts (page 27), and using your Recent Call list (page 27).



Answering Calls

1. Make sure your phone is on.

Note: When your phone is off, calls go directly to voicemail.

2. Press  to answer an incoming call.

Depending on your settings, you may also answer incoming calls by opening the phone or pressing any number key. “Call Answer Mode” on page 84 more information.

Tip: When the phone is closed, you can answer a call by pressing the speaker button () on the top of the phone. To set the phone to answer and end calls by opening and closing the phone, press  > **Settings** > **Phone Calls** > **Flip Activation** and set **Flip To Ans** and **Flip To End to On**.

Your phone notifies you of incoming calls by any combination of ringing or vibrating, the indicator light flashing, the backlight illuminating, or the screen displaying an incoming call message.

If the incoming call is from a number stored in your Contacts, the entry's name is displayed. The caller's phone number may also be displayed, if available.

Ending a Call

- ▶ To end a call, press  or close the phone.

Missed Phone Calls

Missed phone calls are forwarded to voicemail. When you do not answer an incoming call, you will see a Missed Call notification.

To display a Missed Call entry from the notification screen:



- ▶ Press **View** (left softkey). (To dial the phone number, press  after displaying the entry.)

To display a Missed Call entry from standby mode:

1. Press  or  > **Recent Calls**.
2. Highlight an entry and press .

Emergency Calls

Your phone supports emergency calling. Emergency phone calls can be made even when your SIM card is blocked or not in your phone.

- ▶ Dial  and press  to be connected to an emergency response center. If you are on an active call, you must end it before calling 911.

When you make an emergency call, your phone's GPS Enabled feature can help emergency service personnel find you, if you are in a location where your phone's GPS antenna has established a clear view of the open sky and your local emergency response center has the equipment to process location information. See "GPS Enabled" on page 113, and particularly "IMPORTANT: Things to Keep in Mind" on page 113 and "Making an Emergency Call" on page 114, for more information on the limitations of this feature. Because of the limitations of this feature, always provide your best knowledge of your location to the emergency response center when you make an emergency call.



Important: Always report your location to the 911 operator when placing an emergency call. Some designated emergency call takers, known as Public Safety Answering Points (PSAPs) may not be equipped to receive GPS location information from your phone.

Emergency calls cannot be placed while the keypad is locked.

If you have not registered on the network, emergency calls cannot be placed while your SIM card is in your phone.

If you are bringing your phone number to Nextel from your previous carrier, you may receive a temporary telephone number while your Nextel phone is being programmed with your permanent phone number. If you make a call to 911 and the call fails, the 911 emergency response center will not be able to call you back on your Nextel phone if in the meantime, your Nextel phone has been programmed with your permanent telephone number. If the call is disconnected before location and details have been provided, call 911 again and advise that you were disconnected.

In-Call Options

Press  during a call to display a list of available in-call features. To select an option, highlight it and press . The following options may be available:

- **Hold** to place the call on hold.
- **3 Way** to initiate a three-way call.
- **Use Bluetooth** to switch from the phone's microphone to a Bluetooth device.
- **2nd Call** to place a second call.
- **Contacts** to display your Contacts list.
- **Recent Calls** to display Recent Calls list.
- **My Info** to display your phone's Information.
- **Memo** to display the phone's electronic notepad.
- **Datebook** to enter a datebook event.
- **Messages** to create a message.
- **Store** to store a new contact.
- **Record** to record the phone call.
- **GPS** to enter the GPS application.
- **In Call Setup** to modify the in-call features.

Speakerphone

- ▶ Press **[Speaker]** or **Speaker** (right softkey) during a call to route the phone's audio through the speaker or the earpiece.

WARNING: Because of higher volume levels, do not place the phone near your ear during speakerphone use.

Mute

- ▶ Press **Mute** (left softkey) during a call to mute the microphone. Press **Unmute** (left softkey) to unmute the microphone.

End-of-Call Options

After you receive or make a call, the call duration is briefly displayed. You are then automatically taken to the Recent Calls list.

To save a number that is not in your contacts:

- ▶ Highlight an entry and press **Save** (left softkey). (See “Saving a Phone Number” on page 25.)

To view Call Details and Call Info:

1. Select a recent call.
2. Press **[OK]** to view the **Call Details**.
3. Press **[OK]** again to view the **Call Info**.





Saving a Phone Number

1. Enter a phone number and press **[OK]**.
2. Highlight **Store Number** and press **[OK]**.
3. To store a new entry, highlight **[New Contact]** and press **[OK]** to add a new entry.
– or –
Search for an existing contact name and press **[OK]** to save the new number.
4. Enter or edit information as necessary and press **Save** (left softkey) to save the Contact.

For more information about Contacts, see “8. Contacts” on page 97.

Finding a Number

To find Contacts entries, you can either scroll through the list using your navigation key or you can search Contacts entries by name.

1. Press  > **Contacts**.
2. Press **Search** (left softkey).
3. Enter the first few letters of a Contact's name and press . (The first contact entry that matches the entered text will be highlighted.)
4. To display the Contacts entry, press . To dial the entry's default phone number, press .

Phone Numbers With Pauses





You can dial or save phone numbers with pauses for use with automated systems, such as voicemail, conference call, or credit card billing numbers.

There are two types of pauses available on your phone:

- **Wait** sends the next set of numbers when prompted.
- **Pause** automatically sends the next set of numbers after three seconds.

Note: You can have multiple pauses in a phone number and combine waits and pauses.

To dial or save phone numbers with pauses:

1. Enter the phone number.
2. Press and hold  until the letter **P** appears. The **P** represents a three-second pause. For a longer pause, press the letter **P** more than once. Each **P** represents a three-second pause.
– or –
Press and hold  until the letter **W** appears. The **W** means your phone waits before dialing further. A message appears asking about sending the rest of the digits.
3. Enter additional numbers.
4. Press  to dial the number.
– or –
Press  > **Store Number** to save the number in your Contacts.

Note: When dialing a number with a wait, press **Yes** (left softkey) to send the next set of numbers.

Making a Call From Contacts

1. Press > **Contacts**.
2. Highlight an entry and press to dial the default phone number.
– or –

To dial another number from the entry, highlight the name, press the navigation key right or left until the correct number type appears, and then press .

Making a Call From Recent Calls

1. Press or > **Recent Calls**.
2. Highlight an entry and press .

Making a Phone Call Using a Voice Name

If you have created a voice name in Contacts (see page 99), say the voice name into your phone to enter the number.

1. Press and hold until a prompt appears telling you to say the voice name.

2. Say a voice name. Your phone plays the name back to you.
3. The call is placed automatically.

Tip: To stop a phone call from being completed, press .

Making a Phone Call While in a Direct Connect Call

Pressing while in an active Direct Connect lets you initiate a phone call to the other person if their mobile phone number is stored in Contacts.

1. While in a Direct Connect conversation press . (You will see a **Start Call To:** prompt.)
2. Press **Yes** (left softkey) or press to switch from the Direct Connect call to a phone call.

Speed Dialing

Each phone number stored in Contacts is assigned a Speed Dial number, which you can use to call that number. You can store up to 600 numbers in your phone's speed dial memory.

1. Enter a speed dial number and then press **#**.
2. Press **☎** to dial the number.

To use Turbo Dial® for speed dial locations 1–9:

- ▶ Press and hold the appropriate key for approximately two seconds. The display confirms that the number has been dialed when it shows “Calling...”.

Redialing the Last Number

- ▶ Press and hold **☎**.

Nextel Direct Connect

Nextel offers the following Nextel Direct Connect® services:

- **Direct Connect**® allows instant two-way radio communication with another Direct Connect user anywhere on the Nextel National Network (U.S.).
- **International Direct Connect** allows Direct Connect calling to and from select countries.

- **Group Connect**® allows nationwide Direct Connect calling to up to 20 other Direct Connect users at once. (See “Group Connect” on page 30.)
- **Talkgroup**™ allows Direct Connect calling to up to 100 Nextel subscribers in the same Direct Connect network. See “Talkgroups” on page 39.
- **Nextel Direct Talk**™ lets you establish off-network, two-way radio communication between two or more Nextel Direct Talk-capable phones. See “Direct Talk” on page 43.

See www.nextel.com for more details on these Direct Connect services. Pricing for each of these services is based on your service contract.

Making Direct Connect Calls

1. Enter a Direct Connect number. See “Dialing Direct Connect Numbers” on page 29.
2. Press and hold the Direct Connect (DC) button on the left side of your phone. Begin talking after your phone emits a chirping sound.
3. Release the DC button to listen.

A Direct Connect call ends automatically after there is no activity on the call for several seconds.

Dialing Direct Connect Numbers

Every Direct Connect number has three parts:

- An area ID.
- A network ID.
- A member ID.

An asterisk separates each part (for example: 999*999*9999). When you enter a number containing all three parts, you must separate them with asterisks.

Note: The number of digits in each part of a Direct Connect number may vary. For example, your Direct Connect number may be formatted as 999*999*9999, while another valid number may appear as 555*555555*55.

If you are calling or saving a Direct Connect number for a Sprint phone with Direct Connect capabilities, the Direct Connect number may be the same as the wireless phone number. When dialing or saving the Direct Connect number, insert asterisks in place of hyphens (913*555*1234).

Tip: When you store a Direct Connect number in Contacts, be sure to include the entire number, including the asterisks.

Using Just the Member ID

If you are contacting someone sharing your network and area IDs, you only need to enter the member ID (the last part of the number).

1. Enter a member ID.
2. Press and hold the DC button.

Making Direct Connect Calls From Contacts or Recent Calls

If you have numbers stored in Contacts (page 97) or Recent Calls (page 92), you can use these numbers to make calls.

1. Press  > **Contacts** or **Recent Calls**.
2. Highlight an entry and then press and hold the DC button to call the entry's Direct Connect number.

Tip: You can make Direct Connect calls while viewing entry details on either list. Display the entry details or **My Info** from another phone (in Recent Calls) and press and hold the DC button.

Making Direct Connect Calls Using a Voice Name

If you have created a voice name in Contacts, say the voice name into your phone to enter the number.

1. Press and hold the speaker button () until a prompt appears telling you to say the name.
2. Say the name. Your phone plays the name back to you.
3. Press and hold the DC button.

Answering Direct Connect Calls

When you receive a Direct Connect call, your phone emits a tone or vibrates. You then hear the voice of your caller.

1. Wait for the caller to finish speaking.
2. Press and hold the DC button. Continue as you would on any Direct Connect call.
3. Press  to end the call.

A Direct Connect call ends automatically after there is no activity on the call for several seconds.

Group Connect

A Group Connect call is similar to a Direct Connect call to one user, but is made to multiple Direct Connect subscribers at once. You can create Groups from your phone and call up to 20 other Group Connect-compatible phones* anywhere on the Nextel National Network. You can create a Group for one-time use or store it to Contacts so you can call it at any time.

** Not all phones are Group Connect-compatible. See www.nextel.com for more details on Group Connect.*

Note: In order to store Groups to your MOTOROLA BRUTE, you must use the 128K SIM card that came with your phone. The 128K SIM card is labeled "Nextel 600 Contcs & 25 Grps". With this SIM card, a maximum of 25 groups can be added to your MOTOROLA BRUTE. Group entries created with your MOTOROLA BRUTE may not be readable by older iDEN SIM-based phones.

Making Group Connect Calls

1. From Contacts or the Recent Calls list, highlight or select a Group.
2. Press the DC button

Tip: You can also start a Group Connect call by entering or selecting a Direct Connect number. See “Starting a Group Connect Call With a Direct Connect Number” on page 32.

Answering Group Connect Calls

- ▶ Proceed as if answering a Direct Connect call from one user. Only one person at a time may speak on a Group Connect call.

Creating Groups in Contacts

1. Press  > **Contacts**.
2. Select **[New Group]**.
3. To assign a name to the Group, enter the name.

Note: If you do not assign a name, the Group is named “Group” followed by the number of members in the Group. For example, “Group (8)” is a group with eight members.

4. Add Group members. See “Adding Group Members” on page 31.
5. To create a voice name for the Group (optional), select **[Options]** > **Voice Name**. Follow the prompt to

record a Group name. When you have finished, press **Back** (right softkey).

6. Press **Save** (left softkey).

Adding Group Members

You can add Group members that have a Direct Connect number and Group Connect-compatible phone to your Group by selecting them from Contacts, the Recent Calls list, Memo, or by manually entering the Direct Connect number from your keypad. You can also add all members in an existing Group to another Group by selecting the Group name from Contacts.

To add Group members from Contacts, the Recent Calls list, or Memo:

1. While creating a Group, select **[Add Member]**.

Note: To move between Contacts, the Recent Calls list, and Memo, scroll left or right.

2. Highlight desired entries and press . A checkmark appears next to each selected member.

Note: To deselect a member, highlight it and press .

3. Press **Done** (left softkey) and then press **Save** (left softkey) to save the group.

To add Group members manually from the keypad:

1. While creating a Group, select **[Add Number]**.
2. Enter the Direct Connect number.
3. Press **[OK]** and then press **Save** (left softkey).

Starting a Group Connect Call With a Direct Connect Number

1. Press **[DC]** > **Push To Talk** > **Direct Connect**, select entries for a Group Connect call, and go to step four. (To add members or numbers from Recent Calls or Memo, scroll left or right)

– or –

From standby mode, enter a Direct Connect number.

– or –

From Contacts or Recent Calls, highlight an entry containing a Direct Connect number.

2. Press **[DC]** > **New Group** or **Call New Group**.

3. Add more Group members. See “Adding Group Members” on page 31.

4. To save the Group, press **[DC]** > **Store Group**.

– or –

To call without saving, press **Done** (left softkey).

5. To make the call, press the DC button.

Removing Members or Groups

To remove a member from a Group:

1. From Contacts, highlight a Group and press **Edit** (left softkey).
2. Highlight a member and press **[DC]** > **Remove Member**.
3. Press **Save** (left softkey)

Note: You can also select **Remove All Members** however, you will have to add at least two new members to save the edited Group.

To delete a Group from Contacts:

1. From Contacts, highlight a Group.
2. Press **[DC]** > **Delete Group**.

3. Press **Yes** (left softkey).

Storing Groups

To store a group to Contacts from the Recent Calls list:

1. From the Recent Calls list, select a Group and press **Save** (left softkey).
2. Add more information to the entry (optional).
3. Press **Save** (left softkey).

To store a group to Contacts from an active call:

1. During an active Group Connect call, press  > **Store Group**.
2. Add more information to the entry (optional).

Note: You cannot record a voice name during an active call.

3. Press **Save** (left softkey).

Storing Members of Groups

To store a member from the Recent Calls list or within Contacts:

1. Display a Group and press  > **Store Number**.

2. Select a number or member to store.
3. Add more information to the entry (optional).
4. Press **Save** (left softkey).

To store a member from an active call:

1. During an active Group Connect call, press  > **Store Number**.
 2. Select a number or member to store.
 3. Add more information to the entry (optional).
- Note:* You cannot record a voice name during an active call.
4. Press **Save** (left softkey).

Group Connect Call Information

While you are in a Group Connect call, the following appears on the screen:

- The name of the Group.
- The name or the Direct Connect number of the person speaking.
- The number of members who are participating in the Group Connect call.





Group Connect Call Details

During a Group Connect call, you can view details about the other group members, such as their name or Direct Connect number, and their status on the call.

To view Group Connect call details:

- ▶ Press **Details** (left softkey).

In the Details view, these icons appear next to member names or Direct Connect numbers:

-  The member of the Group who is speaking.
-  A member of the Group who is active on the Group Connect call, but not speaking.
-  A member of the Group who has exited the call.
-  A member of the Group who could not be reached on the Group Connect call.
-  A member of the Group whose status is unknown.

Nextel Direct Send

Nextel Direct Send lets you use Direct Connect calls to exchange pictures, My Info, contact information, and Groups with other phones that have this capability.

Nextel Direct Send cannot be used during Talkgroup calls. Pictures cannot be sent in Group Connect calls.

Sending a Picture

When you send a picture using Nextel Direct Send, the picture appears on the display of the receiving phone, and is saved by that phone.

Sending a Picture During a Call

You can send a picture at any time during a Direct Connect call, whether you made or received the call. (Additional charges may apply.)

You cannot talk or listen on a Direct Connect call while a picture is being transmitted. Other activities, such as searching for a picture, do not prevent you from talking or listening.

To send a picture during a call:

1. While in a Direct Connect call, press **Picture** (right softkey). A list of pictures that can be included in a Direct Connect call appears.
2. Select a picture and press the DC button to send it.
3. Wait while the picture is transmitted. The Direct Connect call is temporarily interrupted while a picture is transmitted.
4. When prompted, press the DC button to resume the Direct Connect call.

Note: The first time you send a stored picture after turning the phone on, the message **Picture Fees May Apply** appears and you are prompted to respond. Press **Yes** (left softkey) to send the picture. Press **No** (right softkey) to cancel.



Starting a Call by Sending a Picture

You can start a call by choosing a stored picture from the Media Center.

To do this, you must have the recipient's Direct Connect number and IP address stored in your Contacts.

Tip: When a person sends you My Info from his or her phone, including his or her Direct Connect number and IP address, you can then easily store this information to Contacts from the Recent Calls list.

To start a call by sending a picture:

1. Press  > **Multimedia** > **Media Center** and then highlight or select a picture.
2. Press  > **Send Via...** > **Direct Send**.
3. Select **A Contact** or **A Recent Call**. These names have Direct Connect numbers and IP addresses stored.
4. Select a name and press the DC button to send the picture.
5. When prompted, press the DC button to resume the Direct Connect call.

Receiving a Picture

When someone sends you a picture using Nextel Direct Send, your phone emits a tone or vibrates and a message appears on the display asking you to accept the picture.

Pictures you receive are saved to your phone's memory and are accessible through the Media Center.

When you receive a picture, it appears every time you are in a Direct Connect call with the person who sent it unless you delete the picture from the Media Center. This occurs for the last 20 people who sent you pictures.

To accept a picture:

1. When you see the message asking you to accept the picture, press **Yes** (left softkey). (To decline the picture press **No** [right softkey].)
2. Wait while the picture is transmitted. The Direct Connect call is temporarily interrupted while a picture is transmitted.
3. When prompted, press the DC button to resume the Direct Connect call.

Note: The first time you accept a stored picture after turning the phone on, the message **Picture Fees May Apply** appears and you are prompted to respond. Press **Yes** (left softkey) to accept the picture. Press **No** (right softkey) to cancel.

Tip: To stop the transmission before it is finished, press **Cancel** (right softkey).

Setting Picture Capability

To turn your phone's ability to send and receive pictures in Direct Connect calls on or off:

1. Press **☰** > **Push To Talk** > **PTT Options** > **On/Off Settings**.
2. Select **Pictures** and press **OK** to check or uncheck the box.
3. Press **Done** (left softkey) to save the setting.

This setting does not affect your phone's ability to send and receive My Info or contact information.

Sending My Info and Contact Information

When you send My Info or contact information using Nextel Direct Send, the information you send appears on the display of the receiving phone. After the call, the information appears on that phone's Recent Calls list.

Sending My Info

You can control what portion of the information in My Info is sent and whether it is sent automatically in every Direct Connect call or only when you choose to send it.



Tip: When you send My Info, certain information, such as your email address or fax number, cannot be included. To send complete contact information, create an entry for yourself in Contacts and send it.

The information your phone sends always includes My Name and Direct Connect.

It may include **Line 1**, **Line 2**, **Carrier IP**, **Direct Connect**, and **Group ID** depending on the options provided by your service provider and how you set your sending options.



The default setting is **Line 1** only.

To change which fields are sent:

1. Press  > **Tools** > **My Info**.
2. Press  > **Direct Send Setup** > **Info To Send**.
3. A checkmark appears next to the fields that will be sent. To add or remove the checkmark, select the field.

4. When you are finished, press **Done** (left softkey).

To control whether your information is sent automatically:



1. Press  > **Tools** > **My Info**.
2. Press  > **Direct Send Setup** > **Auto Send**.
3. Select **On** to send your information automatically, or **Off** to send your information only when you choose to send it.

Note: When you receive your phone, it is set to send your information automatically.

To send My Info during a call:

1. While in a Direct Connect call, press  > **Direct Send My Info**.
2. When **Ready To Send** appears, press the DC button to send the information.

To start a call by sending My Info:

1. Press  > **Tools** > **My Info**.
2. Press  > **Direct Send My Info**.
3. Enter a Direct Connect number or press **Browse** (left softkey) and select a number from **Contacts**, **Recent Calls**, or **Memo**.



4. When **Ready to Send** appears, press the DC button to send the information.

Sending Contact Information

You can send contact information by selecting a Contacts entry.

Contacts entries that contain only addresses cannot be sent. When Contacts entries are received, they do not include ring tones or pictures.

To send contact information during a call:

1. While in a Direct Connect call, press  > **Contacts**.
2. Highlight a Contacts entry and press  > **Send Via... > Direct Send**.

Note: If the Contacts entry you scrolled to is a Group, you may be prompted to allow yourself to be a part of the group being sent. Press **Yes** (left softkey) to become part of the group.

3. When **Ready to Send** appears, press the DC button to send the contact information.

To start a call by sending contact information:

1. From Contacts, highlight or select an entry.



2. Press  > **Send Via... > Direct Send**.

Note: If the Contacts entry you scrolled to is a Group, you may be prompted to allow yourself to be a part of the group being sent. Press **Yes** (left softkey) to become part of the group.

3. Enter a Direct Connect number or press **Browse** (left softkey) and select a number from **Contacts**, **Recent Calls** or **Memo**.
4. When **Ready To Send** appears, press the DC button to send the contact information.

Receiving My Info or Contact Information

When you receive My Info or contact information from another phone, an icon appears on the display.

-  My Info
-  Contact Information

To view the information while still in the Direct Connect call:

- ▶ Press  > **View Contact**.

You can also view My Info from other phones on the Recent Calls list. See “7. Recent Calls” on page 92.

Sending Groups Using Direct Send

You can send a Group using Nextel Direct Send so that the person who receives the Group can use the list.

To send a Group from the Recent Calls list:

1. From Recent Calls, highlight a Group and press  > **Send Group**.
2. To include yourself in the Group, press **Yes** (left softkey). To exclude yourself, press **No** (right softkey).

Note: If you choose to include yourself and the Group already contains 20 members, you will be prompted that the list is full. You will be excluded from the list.

3. Enter a Direct Connect number or press **Browse** (left softkey) and select a number from **Contacts**, **Recent Calls**, or **Memo**.
4. When **Ready To Send** appears, press the DC button to send the contact information.

To send a Group from Contacts:

1. From Contacts, highlight a Group and press  > **Send Via....**

2. To include yourself in the Group, press **Yes** (left softkey). To exclude yourself, press **No** (right softkey).
3. Select **Direct Send**.
4. Enter a Direct Connect number or press **Browse** (left softkey) and select a number from **Contacts**, **Recent Calls** or **Memo**.
5. When **Ready To Send** appears, press the DC button to send the Group.

The Group will appear in the Recent Calls list on the phone to which you sent the Group.



Talkgroups

A Talkgroup is a predetermined group of Direct Connect users, created by an account administrator. Talkgroups can contain up to 100 members.

Difference Between Group Connect and Talkgroup Calls

In a Group Connect call, you or another caller determines who can participate in the call. By contrast,

participation in a Talkgroup is determined by an administrator. Here are the ways Group Connect and Talkgroup calls differ.

	Group	Talkgroup
Group Icons		
Geography	Nationwide	Limited to local market and network (fleet)
Maximum Group Size	21 (including originator)	100
Setup	Dynamically, via your phone	Predefined, via Nextel administrator using Talkgroup Management
Voice Activated Dialing	Yes	No

Joining a Talkgroup

To participate in a Talkgroup, the account administrator must first add you to the membership and then you must “join” the Talkgroup.

1. Press **Contacts** (right softkey) and highlight a Talkgroup.
2. Press **Join** (left softkey).

You can now receive communications from other members of this Talkgroup.

You will hear all active Talkgroup conversations on your phone. To silence them, press  > **Push To Talk** > **PTT Options** > **Tkgrp Silent** and then select **On**.

Adding More Talkgroups

You can be included in additional Talkgroups by doing one of the following:

- Using Talkgroup Management at www.nextel.com. You must be an account administrator to use Talkgroup Management.
- Contacting your Nextel Sales Representative at the time of activation.

Making Talkgroup Calls

1. Press  and then enter the Talkgroup number.
– or –

Select the Talkgroup from Contacts or the Recent Calls list.

2. Press the DC button and continue as if making a Direct Connect call.

Receiving Talkgroup Calls

- ▶ Answer it as you would a regular Direct Connect call. Only one person at a time may speak on a Talkgroup call.

During and immediately after a Talkgroup call ends, press **Options** (right softkey) to display any available options.

Call Alerts

Call Alerts let you notify others that you want to communicate with them using Direct Connect. When a user receives a Call Alert, the phone sounds a tone and displays your name or Direct Connect number.

Sending Call Alerts

1. Enter a Direct Connect number and press **Alert** (left softkey).

2. When “Ready to Alert” appears, press the DC button to send the Call Alert.

Note: You can send a Call Alert from Recent Calls or Contacts. Select a Direct Connect number and continue as explained above.

Responding to a Call Alert

Note: You can set a distinctive ringer for Call Alerts. See “Ring Tones” on page 69.

To answer a Call Alert:

- ▶ Press the DC button to make a Direct Connect call to the sender.

To clear a Call Alert:

- ▶ Press **Clear** (right softkey).

To store a Call Alert in the Call Alert queue:

- ▶ Press **Queue** (left softkey).

Note: The Recent Calls list also stores Call Alerts you have received. They appear as Direct Connect calls. Call Alerts remain in your Recent Calls list until you delete them or until they reach the end of the list.



Using the Call Alert Queue

When you queue a Call Alert, it remains in the Call Alert queue until you make a Direct Connect call to the sender or delete it.

Viewing Call Alerts

1. Press  > **Push To Talk > Call Alert**.
2. Scroll through the list.

Viewing Call Alert Date and Time

1. Press  > **Push To Talk > Call Alert**.
2. Select a Call Alert and press .

Responding to Call Alerts in the Queue

After you queue a Call Alert, you can respond to it by making a Direct Connect call to the sender or sending a Call Alert to the sender.

To make a Direct Connect call to the sender:

1. Press  > **Push To Talk > Call Alert**.
2. Highlight a Call Alert and press the DC button to begin the call.



This removes the Call Alert from the queue.

To send a Call Alert to the sender:



1. Press  > **Push To Talk > Call Alert**.
2. Highlight a Call Alert and press **Alert** (left softkey). **Ready to Alert** appears on the display.
3. Press the DC button until **Alert Successful** appears on the display.

Deleting Call Alerts

To delete a Call Alert from the queue:

1. From the Call Alert queue, highlight a Call Alert and press  > **Delete**.
2. Press  or press **Yes** (left softkey) to confirm.



To delete all Call Alerts from the queue:

1. From the Call Alert queue, press  > **Delete All**.
2. Press  or press **Yes** (left softkey) to confirm.

Call Status and Completion

After a failed incoming or outgoing Direct Connect call or Call Alert, you can send a message to the caller or intended recipient.

To set up a message for incoming or outgoing calls:

1. Press  > **Settings** > **Advanced** > **Call Completion** > **Incoming Call** or **Outgoing Call**.
2. In the **Send Msg** field, select **Off**, **Ask First**, or **Automatic**.
3. Select **Message** and create a message to be sent, or press **QNotes** (left softkey) and select a predefined message.
4. Press  and then press **Back** (right softkey).

To send a message after receiving or making a call:

1. After a failed incoming or outgoing Direct Connect call, within five seconds, **Send Text Message To** will appear.
2. Press **Yes** (left softkey) to send your predefined message or press **No** (right softkey) to cancel.

3. To edit a message before sending it, press

 > **Edit**

Direct Talk

Nextel Direct Talk allows for two-way radio communication “off the network” between two or more phones equipped with this capability. This feature is useful in areas without network coverage.

You can make:

- **Code calls** – two-way radio calls conducted off the network and using open channels and codes. In these calls, anyone using your same channel and code can hear your conversation.
- **Private calls** – two-way radio calls conducted off the network and using the wireless phone numbers of the participants. In these calls, others using the same channel cannot listen in.

When using Direct Talk mode, the two phones should be a minimum of six feet apart to maximize performance and improve transmission range. You can only make Direct Talk calls to users located within your

range. This varies according to terrain, man-made structures, and atmospheric conditions.

Most traditional phone features are not available in Direct Talk mode, including on-network phone calls; Direct Connect, Group Connect, Talkgroup calls, and Call Alerts; data services; messaging; call timers; and call forwarding.

Setting Your Phone to Direct Talk

Before you and another caller can use Direct Talk, both of your phones must be set to Direct Talk mode.

1. Press  > **Push To Talk** > **Direct Talk**.
2. Select **Go To Direct Talk**.

After a few seconds, your channel and code appear on the display screen. Your phone displays the last channel and code used for Direct Talk.

To return to network mode from Direct Talk:

1. Press  > **Push To Talk** > **DT Options**.
2. Select **Exit Direct Talk**.

After a few seconds, your phone returns to network service.

Code Direct Talk Calls

To make Direct Talk Code calls, both parties must be on the same channel and code and have their phones set to Direct Talk. Anyone within range who is set to the same code and channel can hear all conversations.

To set a channel and code:

1. In Direct Talk mode, press **Edit** (left softkey) > **Channel**, and then select a channel.
2. Select **Code** and select a code.
3. Press **Back** (right softkey) to return to the Direct Talk standby screen.

Making and Receiving Code Calls in Direct Talk Mode

- ▶ In Direct Talk mode, press and hold the DC button. Your phone displays **Transmitting**, along with the channel and code selected.

The tone emitted from your phone when making a Direct Talk call sounds different from the tone heard on Direct Connect calls conducted on the network.

If you receive an error message, this means:

- There may be no parties on your channel or code.
- You are out of range.

When you receive a Code call using Direct Talk, your phone displays **Receiving**, along with the channel and code selected. Reply as on a Direct Connect call.

Private Direct Talk Calls

Private Direct Talk allows you to silence all the calls on a channel that are not directed specifically at you. To do this, you must first set your phone to Private Only.

To set your phone to Private Only:

1. In Direct Talk mode, press **Edit** (left softkey) > **Code > Pvt Only**.
2. Press **Back** (right softkey) to return to the Direct Talk standby screen.

To reach you, other Direct Talk callers must be on your same channel and dial your ten-digit wireless phone number to reach you.

Note: You do not need to set your phone to Private Only to receive Private calls. If you are on the same channel as your caller, you can receive Private Direct Talk calls.

Making a Private Direct Talk Call

You can make Private Direct Talk calls to any person on your same channel. You do not need to set your phone to Private Only.

To make a private Direct Talk Call:

1. In Direct Talk mode, enter a ten-digit wireless phone number. (You can also select a number from Contacts or Recent Calls.)
2. Make the call in the same way you make a regular Direct Connect call.

If you receive an error message, it means:

- You may not be using a valid wireless phone number.
- The person that you are trying to reach may not be in Direct Talk mode.
- The person that you are trying to reach is set to a different channel, or is out of range.

Receiving All Calls on a Channel

You can set your phone to receive all Direct Talk transmissions that are within range and set to the same channel. Do this by selecting **Receive All**, instead of a code.

You cannot initiate a call when the code is set to Receive All. If you press the DC button to initiate a Direct Connect call and your code is set to Receive All, you receive an error message.

To set the code to Receive All:

1. In Direct Talk mode, press **Edit** (left softkey) > **Code** > **Receive All**.
2. Press **Back** (right softkey) to return to the Direct Talk standby screen.

Making Emergency Calls While in Direct Talk Mode

If you attempt to make an emergency 911 call while in Direct Talk mode, your phone automatically exits Direct Talk mode and attempts to find a network signal.

If you are out of network coverage, your phone cannot make an emergency 911 call until you return to a network coverage area. You must wait until the phone reconnects to a network before attempting to make an emergency 911 call.

4. Service Features: The Basics

- ◆ Message Center (page 47)
- ◆ Receiving Messages (page 48)
- ◆ Voicemail (page 49)
- ◆ Multimedia Messages (MMS) (page 50)
- ◆ Text Messaging (SMS) (page 59)
- ◆ Caller ID Blocking (page 59)
- ◆ Call Waiting (page 60)
- ◆ Making a Second Call (page 61)
- ◆ Making a Three-Way Call (page 61)
- ◆ Call Forwarding (page 61)
- ◆ Making International Calls (page 64)
- ◆ Special Dialing Codes (page 64)
- ◆ Nextel Phone Services (page 65)

Message Center

The message center manages your messages. You can listen to or view voicemail messages, Multimedia Messaging Service (MMS) messages (which include most phone-to-phone text messages), Net alerts, and SMS text messages in the message center.

The message center also lets you create and send MMS messages, including phone-to-phone text messages. It stores messages you have sent and lets you save drafts of messages you are creating.

Accessing the Message Center

- ▶ Press  > **Messages**.

Message Center Options

After accessing the message center, select an option:

- **[Create Message]** — begin creating an MMS message.
- **Voice Mail** — access received voicemail messages.
- **Inbox** — access received MMS and SMS messages.

- **Drafts** — access MMS messages you have created and saved but not sent.
- **Outbox** — store MMS messages that were not sent.
- **Sent Items** — access MMS messages you have sent.
- **Net Alert** — access alerts that you receive from Nextel.

Receiving Messages

When you receive a voicemail message, Multimedia Messaging Service (MMS) message, text message (SMS), or Net alert, you have two ways to access the message:

- Respond to the message notification that appears when the message is received.
- Dismiss the message notification and access the message later through the message center.

Message Notifications

When you receive a message, your phone notifies you with text on the display and a notification tone or vibration. You can access the message or dismiss the notification.

- ▶ To dismiss the message notification, press **Later** (right softkey).



If you dismiss the notification, the message is not deleted. You can access it through the message center.

If you are not on a phone call when you receive a message, your phone sounds a notification tone every 30 seconds until you access the message, you dismiss the notification, or the alert time-out expires.

When you are on a phone call, you can receive message notifications for all types of messages except MMS messages. For other types of messages, your phone may sound a notification tone during the call or after you end the call, depending on how you set your notification options.

For information on notification options, see “Setting Message Notification” on page 75.

Retrieving Your Messages

1. Press  > **Messages**.
2. Highlight a message type and press .

Voicemail

Tip: To receive voicemail messages, you must first set up your voicemail box.

If you are bringing your phone number from another carrier, we suggest you set up your voicemail box after the number you brought to Nextel is active on your Nextel phone and your temporary phone number is deactivated. If you set up your voicemail box prior to this, all messages and all settings (including your greeting and password) will be lost when the number you have brought to Nextel becomes active.

Setting Up Your Voicemail Box

Using your MOTOROLA BRUTE, dial your ten-digit Nextel Personal Telephone Number (PTN). For example: 7035557777. Follow the system instructions to create a new four- to seven-digit password, record your name, and record a greeting. When the system says, "Thank you for using Nextel Voicemail," your mailbox is set up.

If you are setting up your voicemail from a phone other than your MOTOROLA BRUTE, dial your ten-digit Nextel PTN. When you hear the greeting, press **[*]** to

access your voicemail box. The system will prompt you to enter your password. Enter the last seven digits of your Nextel PTN. For example: 5557777. This is your temporary password. Follow the system instructions to complete your mailbox setup.

You are in the main voicemail menu when you hear the voicemail system options.

For details on using your voicemail, follow the audio prompts provided by the voicemail system.

Playing Messages

- ▶ When you receive a new voicemail message, you can either listen to it immediately by pressing **Call** (left softkey), or later by pressing **Back** (right softkey).
- ▶ To listen to your voicemail messages after dismissing the onscreen prompt, press **[*] > Messages > Voice Mail**. You will be connected to your voicemail box.

Multimedia Messages (MMS)

Multimedia Messaging Service (MMS) lets you send and receive messages that may include text, pictures, and audio recordings.

Your MMS address is PTN@messaging.nextel.com. Your PTN is your ten-digit Nextel Personal Telephone Number.

Note: Most common phone-to-phone text messages are sent and received as MMS messages on your MOTOROLA BRUTE. Text messages sent from other phones or mobile devices to your phone number arrive as MMS messages.

Accessing MMS Messages

1. Press  > **Messages**.
2. Select **Inbox** (also includes SMS messages), **Drafts**, or **Sent Items**.
 - If you have more than 9 messages, scroll right or left to display the next or previous page.

To open a message on the current page:

- ▶ Highlight a message and press .

Creating and Sending Messages

Each message you create may contain the following fields:

- **To** – the phone numbers or email addresses of one or more recipients.
- **Message** – the body of the message. This may include text, pictures, ring tones, or voice records.
- **Subject** – the subject line.
- **Attach** – one or more attachments. These may be pictures, ring tones, or audio files, including voice records that you create while creating the message.
- **Cc** – the phone numbers or email addresses of additional recipients.
- **Auto Replies** – lets you insert replies the recipient can choose from when replying to your message, if the recipient's phone also has this feature.
- **Priority** – sets the message priority to normal or high.
- **Valid Until** – sets a date after which no more attempts are made to deliver the message.

To send a message, you must address it to at least one recipient. All other message fields are optional and you can fill them in any order.

Entering Text

In message fields that require you to enter text, you can begin entering the text from the keypad when the field is highlighted.

While entering text, press **[AB]** to choose a text input mode from the context-sensitive menu. (See “Entering Text” on page 16.)

Message Size

You can create and send messages of up to 100 KB, including attachments for MMS. The size of the message appears at the top of the display as you are creating the message.

Sending or Canceling

To send the message at any time after it has been addressed:

- ▶ Press **Send** (left softkey) or press **[AB]** > **Send**.

To cancel the message at any time:

- ▶ At the message screen, press **Cancel** (right softkey) or press **[AB]** to cancel the message and save it in **Drafts**.

Creating a Message

1. Press **[AB]** > **Messages** > **[Create Message]**.

Tip: You can also select **[Create Message]** from Inbox, Drafts, or Outbox or begin messages from Contacts, Recent Calls, Media Center, or standby mode, or by replying to a message in your inbox.

2. Address the message:

- Select **To**. Enter the phone number or email address from the keypad and press **[OK]**. Repeat this action to enter more phone numbers or email addresses.

– or –

Press **Search** (left softkey) to select recipients from Contacts or Recent Calls. Highlight recipient(s), press **[OK]** to select them (entries will be checked), and then press **Done** (left softkey).

- If necessary, press **Back** (right softkey) to return from the Send To screen to the main Message screen.

Tip: To remove a phone number or email address from the list of message recipients, highlight the phone number or email address and press **Remove** (left softkey).

3. To enter or edit the body of the message:
 - Select **Message** and then use any of the following options to enter your message.

Note: If you have created a signature, the signature automatically appears in this field. Text you enter appears before your signature. (See “Adding a Customized Signature” on page 77.)

- Enter text from the keypad.
- Use a Quick Note. See “Quick Notes” on page 54.
- Insert a picture, a ring tone, or an audio file. See page 54.

When you are finished, press **OK**.

4. To send the message without additional options, press **Send** (left softkey) or press **SEND** > **Send**.

Adding More Message Options

1. To view more fields in a message, scroll to **MORE** and press **OK**.
2. To create or edit the subject line, select **Subject**, enter a subject, and press **OK**.



3. To attach a picture, audio, voice recording, or video, select **Attach** > **[New Attach]** and then select an option to attach a file.
4. To add CC's, select **Cc** and add recipient(s).
5. To insert replies the recipient can choose from when replying to your message, select **Auto Replies**.
 - Enter text from the keypad or select a Quick Note (see “Quick Notes” on page 54). Press **Back** (right softkey) when you are finished.
6. To set the priority of the message, select **Priority** and then select a setting.
7. To set a date after which attempts to deliver the message end:
 - Select **Valid Until**, enter a date, and press **OK**.
 - To set no date, press **No Date** (left softkey).
8. To send the message, press **Send** (left softkey) or press **SEND** > **Send**.

Replying to a Message

You can reply to a read message while you are viewing it or while it is highlighted in the Message Center. You cannot reply to unread messages.

When you reply to a message, some of the fields in your reply are filled in automatically. These may include **To**, **Message** (the first 40 characters of the received message), **Subject**, and **Cc**.

To reply to a message:

1. Display or highlight a read message and press **Reply** (left softkey). (To reply to the sender and all recipients, press  > **Reply All**.)
2. Select [**Create Reply**] and enter a reply message or select a short reply from the list.
3. Edit any applicable message fields and press .
4. Press **Send** (left softkey).

Tip: To create new reply phrases to use in later reply messages, see “Quick Notes and Reply Phrases” on page 76.

Note: If the message you are replying to was sent with auto replies, it contains a numbered list of possible replies. Press the number of a reply. The reply is sent immediately without any further action.

More Ways to Begin a Message

In addition to beginning a message from the Message Center, you can begin a message from Contacts, the Recent Calls list, standby mode, or the Media Center.

To begin a message from Contacts:

1. From the Contacts list, highlight an entry.
2. Scroll left or right to view the Contacts types until you see the icon for the phone number or email address to which to send the message.
3. Press **Create** (left softkey) or press  > **Create Message**.
4. Create and send the message.

To begin a message from the Recent Calls list:

1. From the Recent Calls list, highlight an entry.

2. If the entry has more than one phone number stored, display the phone number to which to send the message.
3. Press **Create** (left softkey) or press  > **Create**.
4. Create and send the message.

To begin a message from standby mode:

- ▶ Enter a phone number and press  > **Create Message**.

To begin a message from the Media Center:

1. From the **Media Center**, highlight or select a picture or audio file.
2. Press **Send** (left softkey).
3. Create and send the message. The selected file is automatically included as an attachment.

Quick Notes

When you are filling in the **Message** and **Subject** message fields, you can add preset words or phrases called Quick Notes. After you add Quick Notes, you can edit them as you would any other text.

To insert a quick note:



1. While you are creating a message, highlight or select **Message** or **Subject** and then press **QNotes** (left softkey).
2. Select a Quick Note to insert into the message.

Tip: To add a quick note after you have already started entering a message, press  > **Insert** > **Insert QNotes**, and select a note.

To create new Quick Notes to use in later messages, see “Quick Notes and Reply Phrases” on page 76.

Inserting Pictures or Videos

You can insert pictures or videos from Media Center. If the forward locked icon () appears next to a file, it cannot be included in a message.

1. Highlight the **Message** field and press  > **Insert** > **Insert Picture** or **Insert Video** (You will see a list of available pictures or videos.) Scroll right or left to display files in the phone’s memory or on the memory card.
2. Highlight a picture or video and press .

Note: You can also select **Capture Picture** or **Capture Video** to take a new picture or video to send.

Inserting Audio Files or Voice Records

You can insert audio files from the Media Center or voice records from your voice records list. Preloaded audio files or files with the forward locked icon (🔒) cannot be included in a message.

1. Highlight the **Message** field and press  > **Insert** > **Insert Audio**. (You will see a list of available audio files.)

Tip: To hear an audio file before inserting it, highlight the file name and press **Preview** (left softkey).

2. Highlight an audio file or voice record and press . (Scroll right or left to display available files in the phone's memory or on the memory card.)
 - To record a voice record, select **Record Voice** and record a new voice record.

Removing an Inserted Item

To remove an item inserted into a message:

1. Select the **Message** field and highlight the item by scrolling to the right.
2. Press **Delete** (left softkey).

Note: You can also attach items to messages by selecting **MORE** and then selecting **Attach**.

Drafts

While you are creating a message, you can save it in Drafts before you send it. You can view, edit, send, or delete saved drafts.

Saving a Message in Drafts

- ▶ While you are creating a message, press  > **Save in Drafts** and the message will be saved in drafts.

After saving, you can continue to create the message. The version you saved in Drafts will not change.



Accessing Saved Drafts

- ▶ Press  > **Messages** > **Drafts**.

Sent Items

The Sent Items folder holds all messages that have been sent.

Forwarding Sent Items

1. Press  > **Messages** > **Sent Items**.
2. Highlight a message and press  > **Forward**.
3. Address, edit, and send your message.

Outbox

Messages you tried to send are stored in the Outbox.

Resending Messages

If a message was not sent from your phone, you can resend it.

1. Press  > **Messages** > **Outbox**.
2. Highlight a message and press **Resend** (left softkey).

Note: If your message was sent successfully, **Resend** will not appear as an option.

Receiving a Message

When you receive an MMS message, a message notification appears on the display.

To view the message:

- ▶ Press  or press **Read** (left softkey). The message is downloaded from the message server.

To dismiss the message notification:

- ▶ Press **Later** (right softkey).

This icon  appears on the display, reminding you that you have a new message.

Threaded Inbox

The threaded inbox allows you to organize your messages by subject or sender.

1. From your inbox highlight a message.
2. Press  > **Threading** and select **None**, **Subject** or **Sender**.

Navigating a Message

As you scroll through a message, numbers, email addresses, and Web addresses are highlighted.

Pictures and audio recordings are also highlighted.

Embedded Objects and Attachments

Messages may contain pictures or audio files as part of the body of the message or as attachments.

If a message contains pictures or audio files in the body of the message, highlight each picture or audio file to view or play it.

If a message contains a picture or audio file as an attachment, highlight the attachment and press  to view the picture or play the audio file.

Note: Audio files in messages do not play if **VibeAll** is set to **On**.



Actions for Received Messages

Deleting

To delete unread messages:

1. Highlight a message and press **Delete** (left softkey).
2. Press  or press **Yes** (left softkey) to confirm.

To delete read messages:

1. Highlight or view a message and press  > **Delete Message**.
2. Press  or press **Yes** (left softkey) to confirm.

Forwarding

1. Highlight or view a message and press  > **Forward**.
2. Address, edit, and send your message.

Embedded objects and attachments are included when you forward a message.

Locking and Unlocking

When you lock a message, it cannot be deleted until you unlock it.

- ▶ Highlight or view a message and press  > **Lock Message** or **Unlock Message**.

Calling a Number in a Message

If any field in a message contains a phone number, Direct Connect number, or Talkgroup ID, you can call or send a Call Alert to that number.

To make a call to a number in a message:

1. View the message.
2. Highlight a number and press  to make a phone call or press the DC button to make a Direct Connect call.

To send a Call Alert to a Direct Connect number in a message:

1. View the message.
2. Highlight a Direct Connect number and then press  > **Alert**.
3. Press the DC button.

To make a Talkgroup call to a Talkgroup ID in a message:

1. View the message.
2. Highlight a Talkgroup ID and then press  > **Talkgroup**.
3. Press the DC button.

Storing Message Information to Contacts

If a message you receive contains a phone number, Direct Connect number, Talkgroup ID, or an email address in any of the fields, you can store this information to Contacts.

1. View the message.
2. Highlight a number or email address and then press  > **Save Number** or **Save Email**.
3. Select **[New Contact]** to store the number in a new entry, or select an entry to store the information to an existing entry.
4. With the Contacts type field highlighted, scroll left or right to display a Contacts type for the number or email address.
5. Press **Save** (left softkey).

Going to a Website

If a message contains one or more Web addresses, you can go to the website.

1. View the message.
2. Highlight a Web address and then press  >
Go To Website.

Note: The entire Web address must appear in the message. Otherwise, you cannot go to the website.

Saving Attachments or Embedded Files

1. View a message.
2. Highlight an attachment or an embedded picture or audio file and then press  > **Save Picture**, **Save Audio** or **Save Attachment**.

Text Messaging (SMS)

With text messaging (SMS), you can receive instant text messages from another messaging-ready phone or from an email account.

Your phone's SMS address is PTN@page.nextel.com. Your PTN is your ten-digit Personal Telephone Number.

Note: Most traditional phone-to-phone text messages arrive as MMS messages on your MOTOROLA BRUTE. Your phone can send and receive MMS messages.

Your phone can receive SMS text messages, but it cannot send them.

Accessing Text Messages



- ▶ When you receive a text message, you will see an alert. Press **Read** (left softkey) to display the message.

Caller ID Blocking

Caller ID allows people to identify a caller before answering the phone by displaying the number of the incoming call. If you do not want your number displayed when you make a call, follow these steps.

Per-Call Blocking

To block delivery of your number for a single phone call:

- ▶ Press    before dialing the call.

Your Nextel phone number cannot be blocked from calls made to 911, 800, 855, 866, 877, 888, or other toll-free phone numbers.

Per-Line Blocking

You can request that Nextel Customer Service permanently block delivery of your phone number on every call you make. In this case, you may need to display your number for certain calls.

To show your number on a per-call basis:

- ▶ Press ***82** before dialing the call.

Call Waiting

Call Waiting lets you receive a second call while on an active call. Call Waiting is always available, unless you turn it off for a specific call.

If you are on a call and receive a second call, your phone emits a tone and displays a message.

To accept the second call and put the active call on hold:

- ▶ Press **Yes** (left softkey).

To accept the second call and end the active call:

1. Press **End Call**. Your phone rings with the second call.
2. Answer the second call.

To decline the second call:

- ▶ Press **No** (right softkey). If you subscribe to voicemail, the call is forwarded to your voicemail box, unless you set **Call Forward** or **If Busy** to a different number.

Turn Off Call Waiting

To turn off Call Waiting before a call:



- ▶ Press ***70** before dialing the call. Call Waiting is reactivated once the call ends.

To turn off Call Waiting during a call:

- ▶ Press **Call Waiting** > **In Call Setup** > **Call Waiting** > **Off**.

Tip: To turn Call Waiting back on while still on the call, set this option to **On**.

Making a Second Call

1. Place or receive a phone call.
2. While the call is active, press  > **2nd Call**. (The first call is placed on hold.)
3. Enter a second phone number and press  to place the call.

Note: For quick ways to enter the number, press .

To end the second call and make the on-hold call active:



- ▶ Press .

To make the on-hold call active and put the active call on hold:

- ▶ Press **Switch** (right softkey).



Making a Three-Way Call

With Three-Way Calling, you can talk to two people at the same time. When using this feature, the normal airtime rates will be charged for each of the two calls.

1. During an active phone call, press  > **3 Way**. (The first call is placed on hold.)
2. Enter a second phone number and press .
3. Press **Join** (right softkey).

If one of the people you called hangs up during the call, you and the remaining caller stay connected. If you initiated the call and are the first to hang up, all callers are disconnected.

To merge two calls into a three-way call:

1. During an active phone call, press  > **2nd Call**. (The first call is placed on hold.)
2. Enter a second phone number and press .
3. Press  > **Join**.







Call Forwarding

Call Forwarding lets you forward all your incoming calls to another phone number – even when your phone is turned off. You can continue to make calls from your phone when Call Forwarding is activated.





Call Forwarding sends calls to the phone numbers you specify. You can forward all calls to one number or forward missed calls to different numbers depending on the reason you missed the call.

Forwarding All Calls

When you set your phone to forward all calls, an icon appears in the top row of the display:

-  Phone line 1 is active; calls to phone line 1 are being forwarded.
-  Phone line 1 is active; calls to phone line 2 are being forwarded.
-  Phone line 1 is active; calls to phone lines 1 and 2 are being forwarded.
-  Phone line 2 is active; calls to phone line 1 are being forwarded.
-  Phone line 2 is active; calls to phone line 2 are being forwarded.
-  Phone line 2 is active; calls to phone lines 1 and 2 are being forwarded.

To forward all calls:

1. Press  > **Settings** > **Phone Calls** > **Call Forward** > **Forward** > **All Calls**.
2. Select **To**.
 - If you specified a forwarding number for all calls before, this number appears.
 - To forward calls to this number, highlight it and press .
 - To delete this number, press  and then press and hold **Delete** (left softkey).
3. To enter a forwarding number:
 - Enter the number or press **Search** (left softkey), select **Contacts**, **Recent Calls** or **Memo** and then select a number.
4. Press . All your calls are now forwarded to the number you specified.

Turning Off Call Forwarding

1. Press  > **Settings** > **Phone Calls** > **Call Forward** > **To**.
2. Set this option to **Off**.

All your calls are now sent to your phone.

Forwarding Missed Calls

Calls you miss are forwarded according to the options set for missed calls. By default, missed calls are forwarded to voicemail.

You can specify a forwarding number for each type of missed call:

- **If Busy** — Your phone is on a call or transferring data.
- **If No Answer** — You do not answer on the first four rings.
- **If Unreachable** — Your phone is out of coverage or powered off.

Note: You are charged a higher rate for calls you have forwarded.

To forward missed calls:

1. Press **[☰]** > **Settings** > **Phone Calls** > **Call Forward** > **Forward** > **Detailed**.

Note: If your phone is set to forward all calls, you must first turn off call forwarding to access this option. (See "Turning Off Call Forwarding" on page 62.)

2. Select **If Busy** to specify a forwarding number for calls received when your phone is busy.
3. If you specified a forwarding number for this type of call before, this number displays.
 - To forward calls to this number, highlight it, press **[OK]**, and go to step 6.
 - To delete this number, press **[OK]**, and then press and hold **Delete** (left softkey).
4. To enter a forwarding number:
 - Enter the number or press **Search** (left softkey), select **Contacts**, **Recent Calls** or **Memo** and then select a number.
5. Press **[OK]**.
6. Repeat step 2 through step 5 for **If No Answer** and **If Unreachable**.
7. When you are finished, press **Back** (right softkey).

Making International Calls

Your service default is “International Calls Restricted.” Contact Nextel Customer Service to obtain international dialing access.

Calls placed between the United States and Canada do not require an international access code.

Special Dialing Codes

Non-Emergency Numbers

Nextel supports many “non-emergency” numbers (such as #77, 311, and 511) provided by local and state governments. These numbers are used to report non-emergency incidents. If the situation includes imminent danger or loss of life, you should dial 911.

Telecommunications Relay Service

Nextel supports services for communicating with speech and/or hearing impaired individuals. You can dial 711 to reach a local Telecommunications Relay Center. You will then be connected to your destination

number. Relay service works through a Communications Assistant who reads messages typed into a TDD/TTY device by a speech or hearing impaired individual to you. The Communications Assistant then types your spoken messages to the hearing or speech impaired individual. Telecommunications Relay Service is available 24 hours a day, seven days a week, and every call is strictly confidential.

Note: Using 711 to reach Telecommunications Relay Service may not be available in all areas.

The TTY device must be connected to the phone through the micro USB port. A 2.5 mm to micro USB adapter is required to support TTY.

To enable TTY mode:

1. Press **[Menu]** > **Settings** > **Phone Calls** > **TTY** > **Use TTY**.
2. Select **On** to enable TTY mode.
3. For TTY options, highlight **Type**, press **[OK]** and then select an option:
 - **TTY** – Type and read text on your TTY device.
 - **VCO** (Voice Carry-Over) – Speak into the phone and read text replies on your TTY.

- **HCO** (Hearing Carry-Over) – Type text on your TTY and listen to voice replies on your phone.

Nextel Phone Services

Contact Nextel Customer Service to obtain these services or for additional information.

Note: Some services are not available outside of the continental United States.

Second Line Service

You can have two different phone numbers on the same phone. With Second Line Service, you can:

- Get separate bills for each phone line.
- Bring in an existing wireless or home phone number to Nextel to activate on the second line.
- Have two different area codes (must be in same market) to convey a local image to callers.
- Use different ringer styles so that you can tell which line is receiving a call.
- Forward incoming calls to either your primary or alternate line phone number.

- Choose a Second Line Service plan that fits your needs.

In order to activate Second Line Service, contact your Nextel Sales Representative or call Nextel Customer Service.

To set the active line (primary or alternate):

1. Press **[Menu]** > **Settings** > **Phone Calls** > **Set Line**.
2. Select a phone line to be active.

When incoming calls are made to a non-active line, they will be sent to voicemail without ringing. (See “Call Forwarding” on page 61.)

Sprint 411

Dial 411 from your wireless phone to receive nationwide listings, movie listings and showtimes, restaurant reservations, and driving directions, as well as sports scores, stock quotes, and weather conditions. Spanish speaking operators available. Receive up to three phone numbers or pieces of information per call, and be automatically connected at no additional charge. Airtime and other charges apply.

5. Data Services

- ◆ Wireless Data Services (page 66)
- ◆ Downloading Content (page 68)

Wireless Data Services

With Web access on your phone, you can browse your favorite websites, making it easier than ever to stay informed while on the go. Follow sports scores, breaking news, and weather, and shop on your phone anywhere on the Nextel National Network.

Using the Web Browser

Navigating the Web from your phone is easy once you get the hang of it.

Opening the Browser

- ▶ Press  > **Web** > **Net**.

Options available under the home page include:

- **Business Tools** – Provides access to business tools.
- **Text Messaging** – Provides access to text messaging.
- **Games, Ringers, & More** – Provides access to downloadable items.
- **News, Sports & More** – Lets you access news services.
- **NASCAR** – Gives you access to NASCAR news and stats and provide a link to download NASCAR Sprint Cup Mobile.
- **Email & IM** – Allows you to send email and IMs.
- **Your Bookmarks** – Allows you to access and manage your bookmarks.
- **Search** – Launches a Web search.
- **Go to URL** – Lets you enter website addresses.
- **My Account** – Lets you configure and manage your browser settings.
- **Help** – Displays online help.

Tip: To go back one page, press the  key .

To access the browser menu options, press and hold  from any Web page.

Going to a Specific Website



To go to a particular website by entering a Web address (URL):

1. From the home page, select **Go to URL**.
2. Press **Edit** (left softkey).
3. Use your keypad to enter the Web address and press **Done** (left softkey).
4. Press **Options** (right softkey) > **accept** to go to the website.

Note: Not all websites are viewable on your phone.

Creating a Bookmark

Bookmarks allow you to store the address of your favorite websites for easy access at a later time.

1. Go to a Web page and press and hold  to open the browser menu.
2. Highlight **Mark this page** and press .
3. Confirm or edit the bookmark name, scroll to the bottom of the screen, and then press **Done** (left softkeys) to save the bookmark.

Note: Bookmarking a page does not store the page contents, just its address.



Some pages cannot be bookmarked. Whether a particular Web page may be marked is controlled by its creator.

Accessing a Bookmark

From the home page:

1. Select **Your Bookmarks**.
2. Highlight a bookmark and press  (or press the number corresponding to the bookmark).

From any other Web page:

1. Press and hold  to open the browser menu.
2. Select **View Bookmarks**.
3. Select a bookmark and press  (or press the number corresponding to the bookmark).

Tip: To return to the home page from any other Web page, press .

Reloading a Web Page

1. Press and hold  to open the browser menu.
2. Select **Refresh this page**. (The browser will reload the current Web page.)

Restarting the Web Browser

If the Web browser seems to be malfunctioning or stops responding, you can usually fix the problem by simply restarting the browser.

1. Press and hold  to open the browser menu.
2. Select **More... > Restart Browser**.

Downloading Content

Your phone arrives with Java applications and games loaded and ready to install. You can download and install more Java applications. For more information on Java Security, see “Setting Privacy for Each Java Application” on page 88.

Check the **Games, Ringers & More** menu option for a catalog of items available for purchase and download.

You can also go to www.nextel.com and sign on to your account for a wide selection of available Java applications and downloading instructions.

Note: Using Java applications may cause your phone's battery power to deplete more quickly.

6. Settings

- ◆ Sound Settings (page 69)
- ◆ Display Settings (page 73)
- ◆ Messaging Settings (page 75)
- ◆ Airplane Mode (page 77)
- ◆ Setting One Touch Direct Connect (page 78)
- ◆ Headset Options (page 78)
- ◆ Profiles (page 78)
- ◆ Phone Setup Options (page 82)
- ◆ DC/GC Options Menu (page 88)
- ◆ Security Settings (page 89)

Sound Settings

Ring Tones



Your phone provides a variety of ringer options that allow you to customize your ring and volume settings. These options allow you to identify incoming calls and messages by the ring.

Selecting Ringer Types



1. Press **[M]** > **Multimedia** > **Ring Tones**.
2. Scroll through the list of ring tones. A sample ringer will sound as you highlight each option.
3. Press **[OK]** or press **Assign** (left softkey).
4. Select the function(s) to which to assign the current ringer by highlighting the option and pressing **[OK]**. (A check mark appears next to selected options.)
5. When you are finished, press **Done** (left softkey) to assign the ringer to the selected function(s).

Assigning a Ring Tone to a Contact

You can also assign a ringer to a specific contact entry so you know who's calling without looking at the phone.

1. Press  > **Multimedia** > **Ring Tones**.
2. Scroll through the list of ring tones and select one. A sample ringer will sound as you highlight each option
3. Press  or press **Assign** (left softkey).
4. Select **A Contact....**
5. Highlight a Contacts entry and press  to assign the ringer.

Viewing Ring Tone Assignments

1. Press  > **Multimedia** > **Ring Tones**.
2. Make sure **Vibrate All** is set to **Off**.
3. Highlight any ring tone and then press  > **Overview**.
4. Scroll to view ring tones assigned to features and Contact entries.

Downloading More Ring Tones



To use other ring tones, you can download them into your phone for a fee.

- ▶ Press  > **Multimedia** > **Ring Tones** > **Buy Ring Tones**.

Note: Ring tones may be downloaded only once. If you delete a ring tone from your phone and wish to reassign it, you must purchase it again.

Managing Memory

To view the amount of memory available for custom ring tones:

1. Press  > **Multimedia** > **Ring Tones**.
2. Make sure **Vibrate All** is set to **Off**.
3. Highlight any ring tone and press  > **Memory Usage**.



Deleting custom ring tones frees memory.

Deleting Ring Tones

Deleting a ring tone from the list deletes it from your phone.

In most cases, when you delete a ring tone that you purchased from your phone, you will have to purchase it again.

To delete a ring tone:

1. Press  > **Multimedia** > **Ring Tones**.
2. Make sure **Vibrate All** is set to **Off**.
3. Highlight a ringtone and press  > **Delete**.
4. Press **Yes** (left softkey) to confirm.

Vibrate Settings

Vibrate All

The Vibrate All option allows you to be notified of calls and messages with a vibration instead of an audible alert.

To activate Vibrate All:

- ▶ Press and hold the volume button down in standby mode. (Pressing and holding displays “VibeAll: On.” Continuing to hold the button down displays “VibeAll: Locked.”)
- or –



Press  > **Multimedia** > **Ring Tones** > **Vibrate All**. Set this option to **On** or **Locked**.

Tip: Setting this option to Locked requires you to press and hold the volume control up to turn **Vibrate All** off. The **Locked** option helps prevent you from accidentally turning **Vibrate All** off.

To deactivate Vibrate All:

1. Press and hold the volume key up to unlock vibrate all.
2. Press the volume key up repeatedly to select a volume level or press  > **Multimedia** > **Ring Tones** > **Vibrate All** > **Off**.

These icons indicate how the ringer is set:



-  The phone always vibrates instead of making a sound.
-  The phone vibrates instead of making a sound for phone calls.
-  Direct Connect calls, Group Connect calls, and Talkgroup calls are heard through the earpiece, not the speaker.

 The phone vibrates then rings for all calls.

 The ring volume is set to zero for all calls.

Ring and Vibrate

To set your phone to ring and vibrate when you receive phone calls or Call Alerts:

1. Press  > **Multimedia** > **Ring Tones**.
2. Make sure **Vibrate All** is set to **Off**.
3. Scroll through the list and select a ring tone.
4. Press  > **Assign w/Vibe**.
5. Select **Phone Line 1** and/or **Phone Line 2** and press **Done** (left softkey).

This icon  appears on the display.

Note: You can also set 3D sound effects settings in the Ring Tones menu ( > **Multimedia** > **Ring Tones** > **3D Effect**) or when assigning a ring tone.

Silence All

The Silence All option allows you to mute all sounds without turning your phone off.

To activate Silence All:

- ▶ With the phone in standby mode press and hold the volume key down until the ringer level is set at 0. (The screen will display )

To deactivate Silence All:

- ▶ Press the volume key up repeatedly to select a volume level.

To set your phone to vibrate instead of making a sound for some features but not others:

1. Press  > **Multimedia** > **Ring Tones**.
2. Make sure **Vibrate All** is set to **Off**.
3. Select **Vibrate** from the list of ring tones.
4. Select the feature(s) to which to assign Vibrate and press **Done** (left softkey).

Note: To set ring options for Direct Connect calls, Group Connect calls, and Talkgroup calls, see "Vibrate Settings" on page 71.

Adjusting the Phone's Volume Settings

Adjust your phone's volume settings to suit your needs and your environment.

1. Press **[Menu]** > **Settings** > **Volume**.
2. Select **Ringer/Alerts, Speaker, Earpiece, Multimedia** or **Keypad**.
3. Choose a volume level and press **[OK]**.

Tip: You can adjust the ringer volume in standby mode (or the earpiece volume during a call) by using the volume key on the left side of your phone.

Beep

Set your phone to alert you with an audible tone once a minute during a voice call.

1. Press **[Menu]** > **Settings** > **Phone Calls** > **Minute Beep**.
2. Highlight **On** or **Off** and press **[OK]**.

Display Settings

Changing the Backlight Time Length

Select how long the display screen and keypad remain backlit after any keypress is made.

1. Press **[Menu]** > **Settings** > **Display/Info** > **Backlight**.
2. Highlight an option, press **[OK]**, and then choose a setting.
 - For **Timer** or **Java Timer**, select a time.

Note: Long backlight settings reduce the battery's talk and standby times.

Changing the Display Screen

Choose what you see on the internal or external display screen while powering on or off and when in standby mode.

1. Press **[Menu]** > **Settings** > **Display/Info** > **Wallpaper** > **Internal** or **External**.

2. Select an image and press **View** (left softkey) to view it. Press **Back** (right softkey) to return to the available images.
3. Press **OK** to assign an image.

Setting Wallpaper to Change Automatically

When you set your wallpaper to change automatically, your phone uses each of the pictures in **Media Center** as wallpaper, cycling through them at a pace you choose.

1. Press **Menu** > **Settings** > **Display/Info** > **Wallpaper** > **Internal** or **External** > **Auto Cycle**.
2. Select how frequently the wallpaper will change then press **OK**.

Changing the Phone's Menu Style

Choose how your phone's menu is displayed on the screen.

1. Press **Menu** > **Settings** > **Display/Info** > **Menu View**.
2. Highlight an option and press **OK**.
 - **Icon View** to view the main menu as a grid of icons. Icons animate when they are highlighted.

- **List View** to display the menu as a list.
- **Tab View** to display the menu as a row of icons on the bottom of the screen.

Changing the Theme

Customize your phone's display appearance by selecting a theme to reflect your personality.

1. Press **Menu** > **Settings** > **Display/Info** > **Theme**.
2. Highlight an option and press **OK**.

Changing the Clock Display



Select a format for the time and date display and choose whether the time and date appear in standby mode.

1. Press **Menu** > **Settings** > **Display/Info** > **Clock**.
2. Select **Display On/Off**, **Time Format** or **Date Format** and then press **OK**.
3. Select an option and press **OK** to apply the setting.

Note: The year is set by the network, and even though it is an option, it cannot be changed.

Changing the Text Size

Adjust the font when entering text (for example, when using the notepad or when adding a Contacts entry).

1. Press  > **Settings** > **Display/Info** > **Text Size**.
2. Highlight an option and press .

Messaging Settings



Staying connected to your friends and family has never been easier. With your phone's advanced messaging capabilities, you can send and receive many different kinds of text messages without placing a voice call. (For more information see "Multimedia Messages (MMS)" on page 50.)

Messaging settings make messaging easier by letting you decide how you would like to be notified of new messages, create a signature with each sent message, and create your own preset messages.

Setting Message Notification

When you receive a message, your phone notifies you by displaying an icon on your display screen. You can

also choose to be notified with a sound while making a phone call.

1. Press  > **Settings** > **Phone Calls** > **Notifications**.
2. Highlight **Receive All**, **Message Mail Only** or **Delay All** and press .

Note: **Delay All** is the default setting.

Tip: To set notification options during a call press  > **In Call Setup** > **Notifications**.

Customizing MMS

The Setup menu lets you customize MMS for your phone:

- **Signature** — Enter text here to create a signature that is automatically inserted at the end of each message.
- **Quick Notes** — lets you create new Quick Notes and edit or delete Quick Notes you have created.
- **Cleanup** — controls how long messages remain in the Inbox and Sent Items before they are deleted.
- **Report Default**— allows you to set the default for the Delivery Report Option to on or off.
- **Memory Size** — displays a report on phone memory.

- **MMS Setup** — allows you to set up the following:
 - **Friendly Name** — lets you enter the name displayed in the From field on messages you send.
 - **Download Options** — lets you control message downloads. **Automatic** downloads messages automatically. **Manual** requires you to reply to a prompt before messages download to your phone.
 - **Replies** — lets you create new reply phrases and edit or delete reply phrases you have created.

To access the Setup menu:

1. Press  > **Messages**.
2. Highlight **[Create Message]** and press  > **Setup**.

Tip: This option is available from many context-sensitive menus when you are using MMS.

Quick Notes and Reply Phrases

To add a Quick Note or Reply phrase:

1. From the Setup menu, select **Quick Notes** or **MMS Setup > Replies**.

2. Select **[New Quicknote]** or **[New Reply]**, or press **New** (left softkey).
3. Enter text and press .

To edit a Quick Note or reply phrase:

1. From the Setup menu, select **Quick Notes** or **MMS Setup > Replies**.
2. Select a Quick Note or reply phrase you have created.
3. Edit the text and press .

To delete a Quick Note or reply phrase:

1. From the Setup menu, select **Quick Notes** or **MMS Setup > Replies**.
2. Highlight a Quick Note or reply phrase you have created.
3. Press **Delete** (left softkey) and then press  or press **Yes** (left softkey) to confirm.



Note: You can edit or delete all Quick Notes. You can only edit or delete Reply phrases that you created.

Setting the Cleanup Option

The cleanup option controls how long messages remain in the Inbox and Sent Items before they are deleted. You set the cleanup option for the Inbox and Sent Items separately.

The cleanup option deletes only read, unlocked messages.

To set the cleanup options:

1. From the Message Center, press  > **Setup** > **Cleanup** > **Inbox** or **Sent Items**.
2. Choose a cleanup option.
3. To automatically delete messages now, press  or press **Yes** (left softkey). To delete messages later, press **No** (right softkey).

Adding a Customized Signature

Add a customized signature to each message you send.



1. Press  > **Messages** >  > **Setup** > **Signature**. If you do not wish to attach a signature to your outgoing messages, press **Delete** (left softkey).

2. Enter a signature and press . (See “Entering Text” on page 16.)

Airplane Mode

Sometimes you may want to have your phone on, but turn off its ability to make and receive calls and other transmissions.

To set your phone so that it cannot make or receive phone calls, Direct Connect calls, Group Connect calls, Talkgroup calls, or transfer data:

1. Press  > **Settings** > **Advanced** > **Transmitters**.
2. Select **Off** and press .
3. Press **Yes** (left softkey).

When in Transmitters Off mode, your phone’s standby screen displays “Transmitters Off.”

Note: While powering on your phone, you can turn transmitters off by pressing  for more than five seconds.

To restore your phone's ability to do all these things:

- ▶ Set this option to **On** and then press **Yes** (left softkey).

Note: When Transmitters is set to **Off**, your phone's Bluetooth capability is disabled, and all active Bluetooth connections are dropped.

Setting One Touch Direct Connect

One Touch Direct Connect sets your phone to call the most recent Direct Connect number or Group on the Recent Calls list, or a Direct Connect number you choose, every time you press the DC button.

1. Press **[M3]** > **Push To Talk** > **PTT Options** > **One Touch DC**.
2. Select from **Off**, **Quick PTT**, **Last Call**, **Assigned Number**, **Send Picture**, **Send My Info** or **Send Contact** and press **[OK]**.

Tip: If you are entering a Talkgroup number, enter # before the number.

Headset Options

To set your phone to send incoming sound to a headset only, or to a headset and a speaker at the same time:

1. Press **[M3]** > **Settings** > **Advanced** > **Headset/Spkr**.
2. Select **HdsetOnly** to send incoming sound to the headset only.

– or –

Select **Hdset&Spkr** to send incoming sound to the headset and ring tones to the speaker.

Profiles

A profile is a group of settings saved together so that you can apply them to your phone easily.

Your phone arrives with preset profiles. You can also create your own profiles.

Viewing Profiles

To view the profiles stored in your phone:

1. Press **[M3]** > **Tools** > **Profiles**.

2. Highlight a profile and press **View** (left softkey).

Tip: The profile that is currently in effect on your phone has a checkmark next to it.

3. Scroll to view settings.

Switching Profiles

1. Press **[Menu]** > **Tools** > **Profiles**.
2. Highlight a profile and press **[OK]**.

The profile you selected is now in effect.

How Changing Settings Affects Profiles

Many of the settings contained in profiles can be set without switching or editing profiles — for example, by selecting **Settings** or **Ring Tones** to set options, or by setting the volume of the phone's ring using the volume controls.

When you do this, your phone either:

- Updates the profile in effect to reflect these changes, without notifying you.
- or –

- Creates a temporary profile that contains these changes.

To set your phone to create a temporary profile that contains changes you make to settings:

1. Press **[Menu]** > **Tools** > **Profiles**.
2. Press **[Menu]** and then select **Setup** > **Temp Profile**.
3. Set this option to **On**.

To set your phone to update the profile in effect to reflect any changes you make to settings:

- ▶ Set **Temp Profile** to **Off** in step 3 above.

Temporary Profiles

If your phone is set to create temporary profiles, a temporary profile is created when you make changes to settings without switching or editing profiles. These stay in effect until you switch profiles or power off your phone.

Temporary profiles and any settings you have changed are marked with asterisks (*).

Storing a Temporary Profile

To store a temporary profile as a new profile:

1. Press **☰** > **Tools** > **Profiles**.
2. Highlight the temporary profile and press **☰** > **Store As New**.
3. Enter a name and press **OK**.

To overwrite the profile the temporary profile is based on:

1. Press **☰** > **Tools** > **Profiles**.
2. Highlight the temporary profile, press **☰** > **Store Changes**, and then press **Yes** (left softkey).

Note: The temporary profile is stored with the name of the profile it is based on. The profile it is based on, as it existed before you made changes to settings, is gone.

Creating Profiles

1. Press **☰** > **Tools** > **Profiles** > **[New Profile]**.
2. Enter a name and press **OK**.
3. To base this profile on an existing profile, select **Copy From** and then select a profile and press **OK**.

If you do not choose a profile to copy from, the new profile is based on a default profile.

4. Press **Create** (left softkey).
5. Scroll through the list of options and set their values.
6. When you are finished, press **Done** (right softkey).

Editing Profiles

1. Press **☰** > **Tools** > **Profiles**.
2. Highlight a profile, press **☰** and then select **Edit**.
3. Scroll through the list of options and set their values.
4. When you are finished, press **Done** (right softkey).

Deleting Profiles

To delete a profile:

1. Press **☰** > **Tools** > **Profiles**.
2. Highlight a profile, press **☰**, and then select **Delete**.
3. Press **OK** or press **Yes** (left softkey).

To delete all profiles:

1. Press **☰** > **Tools** > **Profiles**.
2. Press **☰** and then select **Delete All**.
3. Press **OK** or press **Yes** (left softkey) to confirm.

Setting Call Filtering

The call filtering setting in each profile lets you control which calls, Call Alerts, and message notifications your phone notifies you of, and which it ignores.

1. While setting options for a profile, select **Call Filter**.
2. Select a filtering option
 - **Phone** – sets filtering options for phone calls.
 - **Off** – notifies you of all calls.
 - **All** – ignores all calls.
 - **All Contacts** – notifies you only of calls from Contacts.
 - **Some Contacts** – notifies you only of calls from selected Contacts. Select up to five Contacts entries. When you are finished, press **Done** (right softkey).

- **DC/GC** – sets filtering options for Direct Connect calls and Talkgroup calls.
 - **Off** – notifies you of all DC and Talkgroup calls.
 - **On** – ignores all DC and Talkgroup calls.
- **Group** – sets filtering options for Group Connect calls.
 - **Off** – notifies you of all Group Connect calls.
 - **On** – ignores all Group Connect calls.
- **Alerts** – sets filtering options for Call Alerts.
 - **Off** – notifies you of all Call Alerts.
 - **On** – ignores all Call Alerts.
- **Notifications** – sets filtering options for message notifications.
 - **Off** – notifies you of all messages.
 - **Voice Messages** – ignores all voice messages.
 - **Text Messages** – ignores text messages.
 - **All** – ignores all messages.

Note: The message notification screen still appears when you receive a message you have set not to sound a tone or vibrate.

3. Press **Done** (right softkey).





Phone Setup Options

Shortcuts

Your phone offers you the option of assigning shortcuts to favorite or often-used functions. Pressing the  key in standby mode followed by the assigned shortcut key will launch your personally designated shortcuts.

Creating a Shortcut

Note: When you receive your phone, all number keys may already be assigned to shortcuts. If this is the case, you can create new shortcuts by deleting or replacing existing shortcuts.

1. Go to a menu item.
For example, to create a shortcut to the screen for creating a new Contacts entry: Press  > **Contacts** and then highlight **[New Contact]**.
2. Press and hold  until a confirmation screen appears.
3. Press  or press **Yes** (left softkey).
4. Press a number key for the shortcut and press .

5. To record a voice name for the shortcut, select **Voice** (optional). Follow the prompts to say and repeat the name. Speak clearly into the microphone.
6. Press **Done** (left softkey).
7. If the number key you select is already assigned to a shortcut, a prompt appears asking to replace the existing shortcut.
 - Press **Yes** (left softkey) to replace the existing shortcut.
 - Press **No** (right softkey) to keep the existing shortcut and assign another number key.

Using a Shortcut

To access a shortcut using the shortcut number:

1. From standby mode, press .
2. On your keypad, press the number assigned to the shortcut.

To access a shortcut using the voice name:

1. Press and hold  (the speaker button on top of the phone).



- Say the voice name you assigned to the shortcut. The shortcut with that voice name is then highlighted.

To view a list of your shortcuts:



- ▶ Press  > **Settings** > **Personalize** > **Shortcuts**.

Editing a Shortcut

To change the order of shortcuts:



- Press  > **Settings** > **Personalize** > **Shortcuts**.
- With any shortcut highlighted, press  > **Reorder**.
- Highlight the shortcut you are moving and press **Grab** (left softkey).
- Scroll to a new location and press **Insert** (left softkey).
- Repeat step 2 through step 4 for all the items you are moving.
- Press **Done** (right softkey).

To change the number or voice name assigned to a shortcut:



- Press  > **Settings** > **Personalize** > **Shortcuts**.
- Highlight any shortcut and press **Edit** (left softkey).
- With **Key** or **Voice** highlighted, press  to change assignments.
- Press **Done** (left softkey).

Deleting Shortcuts

To delete a shortcut:

- Press  > **Settings** > **Personalize** > **Shortcuts**.
- Highlight a shortcut and press  > **Delete**.
- Press  or press **Yes** (left softkey) to confirm.

To delete all shortcuts:

- Press  > **Settings** > **Personalize** > **Shortcuts**.
- With any shortcut highlighted, press  > **Delete All**.
- Press  or press **Yes** (left softkey) to confirm.

Carousel

Carousel is an iconic list of application shortcuts displayed horizontally at the bottom of the display in standby mode that allows you to access a total of nine applications.

To scroll through the list of icons, press the navigation key right or left to highlight an icon, and press **OK** to select the icon.

Configuring Auto Hide Settings

- ▶ Press **Menu** > **Settings** > **Personalize** > **Carousel** > **Auto Hide**.
 - Select from **Always On**, **2 sec**, **4 sec**, or **8 sec**.

Note: Carousel will not time out if **Always On** is selected.

Assigning Carousel Applications

1. Press **Menu** > **Settings** > **Personalize** > **Carousel**.
2. Assign applications to **Left 1**, **Left 2**, **Left 3**, **Left 4**, **Center**, **Right 1**, **Right 2**, **Right 3**, and **Right 4**.
3. Press **OK** to assign the applications.

Personalize

In addition to Shortcuts, the Personalize menu gives you other options to access menu items easily.

- ▶ Press **Menu** > **Settings** > **Personalize**, select an option, and set your preferences.
 - **Reorder Menu** to change the main menu order.
 - **Up Key**, **Down Key**, **Left Softkey**, **Right Softkey**, to set one-touch menu access from the standby screen.
 - **Power Up** to set the menu item displayed when you power on your phone. (**Default Ready** starts in standby mode.)

Call Answer Mode

Select how to answer incoming calls on your phone.

1. Press **Menu** > **Settings** > **Phone Calls**.
 2. Select an option and press **OK**.
 - **Any Key Ans:** Select **On** to allow you to answer an incoming call by pressing any key.
- or –

Select **Off** to require you to press  to answer all incoming calls.

- **Auto Ans** to set your phone to automatically answer an incoming call after a specified number of rings when connected to a headset or hands-free car kit.
 - **Off** to disable Auto-Answer.
 - **1 Ring, 2 Rings, 3 Rings** or **4 Rings** to answer calls automatically when the phone is connected to a hands-free car kit or a headset (sold separately). In Auto-Answer mode, your phone will answer calls even if you are not present.
- **Flip Activation** to set your phone to answer calls by opening the phone (**Flip To Ans**) and end calls by closing the phone (**Flip To End**).



Display Language

You can choose to display your phone's onscreen menus in several languages.

1. Press  > **Settings** > **Display/Info** > **Language**.
2. Highlight **English, Español, Français** or **Automatic** and press .

Setting Prepend Dialing

The Prepend feature lets you set a prefix to be added to the beginning of all dialed numbers, such as a country code for international calls.

1. Press  > **Settings** > **Phone Calls** > **Prepend**.
2. Select **Prepend** > **On**.
3. Enter a prefix in the **Number** field (such as +1 for international calls) and then press .
 - To deactivate this feature, select **Off** during step 2 above.

Note: This setting does not apply to 911 or Sprint 411.

Resetting Your Phone

Resetting Phone Settings

Resetting phone settings restores all the factory defaults, including the ringer types and display settings. The Recent Calls, Scheduler, and all text messages will be erased. Contacts are not affected.

1. Press **☰** > **Settings** > **Advanced** > **Reset Defaults** > **Reset Settings**.
2. Enter your phone's six-digit security code and press **Ok** (left softkey). (A disclaimer is displayed.)

Note: Your security code is a six-digit number used for resetting your phone. Please contact Nextel Customer Service if you do not know your security code.

3. Read the prompt and press **Yes** (left softkey) to complete the reset. (Press **No** [right softkey] to cancel.)

Resetting All

Selecting **Reset All** resets phone settings and clears all phone data, including Contacts, History, Scheduler, and Messaging.

1. Press **☰** > **Settings** > **Advanced** > **Reset Defaults** > **Reset All**.
2. Enter your security code and press **Ok** (left softkey).
3. Read the prompt and press **Yes** (left softkey) to complete the reset. (Press **No** [right softkey] to cancel.)

GPS Privacy Options

Your phone's GPS privacy options control whether Java applications or other software applications on your phone may view the location of your phone. You may set your phone to one of these GPS privacy options.

Note: Privacy options do not apply to the transmission of location information during emergency 911 calls.

To set your GPS privacy options:

1. Press **☰** > **Tools** > **GPS** > **Privacy**.
2. If your GPS PIN security feature is enabled, enter your GPS PIN. (See "Setting the GPS PIN Security Feature" on page 87. for more information.)
3. Select a privacy option:
 - **Restricted** — No Java or similar software applications may view the location of your phone. However, location information may still be available to the phone's owner, fleet manager, or account administrator.
 - **Unrestricted** — All applications may view the location of your phone, without notifying you.

- **By Permission** — When an application attempts to view the location of your phone, you will be prompted to give permission. However, location information may still be available to the phone's owner, fleet manager, or account administrator.

Setting the GPS PIN Security Feature

To prevent your GPS privacy settings from being altered without your knowledge, your GPS privacy option can be protected by a PIN.

When you receive your phone, the GPS security feature is turned off, so you do not have to enter a GPS PIN to access your GPS privacy options. If you turn this feature on, you will be required to enter a GPS PIN to access your GPS privacy options.

To turn the GPS Enabled security feature on or off:

1. Press  > **Settings** > **Security** > **GPS PIN**.
2. Select **On** or **Off**.
3. Enter the current GPS PIN.

Tip: The default GPS PIN is 0000.

4. Press **Ok** (left softkey).

To change your GPS PIN:

1. Press  > **Settings** > **Security** > **Change Passwords** > **GPS PIN**.
2. Enter the current GPS PIN and press **Ok** (left softkey).
3. Enter the new GPS PIN and press **Ok** (left softkey).
4. Reenter the new GPS PIN to confirm and then press **Ok** (left softkey).

Java Applications & GPS Security

Some Java applications can make use of your phone's GPS feature to determine the approximate geographical location of your phone. (See "GPS Enabled" on page 113 for more information on the GPS feature.) However, for privacy reasons, you may not always want Java applications to access the location of your phone. Your phone protects your privacy by giving you the option to block all or some Java applications from accessing the location of your phone.

Setting Privacy for All Java Applications

See "GPS Privacy Options" on page 86 for instructions on setting the privacy options for your java applications.

These options control the privacy of all Java applications on your phone.

Granting or Denying Permission

When a java application requests access to the location of your phone, a screen appears informing you.

To grant or deny a request:

1. Press **Grant** (left softkey) or **Deny** (right softkey) to grant or deny a request.
2. Select **Always** to always take this action for the application, **For this session** to keep this action without notification until the phone is powered off, or **Only Once** to take this action for this instance only (you will be prompted again for subsequent requests).

Setting Privacy for Each Java Application

1. Press  > **Games and Apps**.
2. Highlight an application or suite of applications.

Tip: If the application has requested access to the location of your phone, this icon  appears when you highlight the application.

3. Press  > **Permissions**.

4. Select privacy options for this application (you may set them for each of the menus available under **Permissions**):

- **Always** — The application always has permission to access the phone's location without notification.
- **Ask** — When the application requests access to the phone's location, you are prompted to grant or deny permission (see “Granting or Denying Permission” on page 88).
- **Never** — Requests for location are denied without notification.

DC/GC Options Menu

The **PTT Options** menu controls how your phone handles Direct Connect calls, Group Connect calls, and Talkgroup calls.

To access the DC/GC Options menu:

- ▶ Press  > **Push To Talk** > **PTT Options**.
 - **Tkgrp Silent** — controls whether you hear your Talkgroup calls.

- **Tkgrp Area** — lets you define your Talkgroup area.
- **One Touch DC** — sets One Touch Direct Connect.
- **Alert Type** — controls how your phone notifies you when you receive Direct Connect calls, Group Connect calls and Talkgroup calls.
- **On/Off Settings** — sets your phone's ability to send and receive pictures in Direct Connect calls. See “Starting a Call by Sending a Picture” on page 35.
- **Store Received Info** — lets you specify a prefix, such as a country code for international calls, to be automatically added to phone numbers you receive in My Info from other phones, when you store the My Info to Contacts. Select **Prefix** to enter the prefix to be added. Set **Add Prefix** to **Ask Me** to set your phone to display a prompt asking you whether to add the prefix as you save My Info from other phones to Contacts.

Security Settings

SIM Card Security

Important: Except for making emergency calls, your phone does not function without the SIM card.

SIM Card's PIN

You can protect access to your phone by using the SIM card's PIN (Personal Identification Number). When you enable SIM PIN, you must enter the PIN each time you power up the phone. You can change or disable the SIM PIN.

Turning SIM PIN On and Off

1. Press  > **Settings** > **Security** > **SIM PIN**.
2. Select **On** or **Off**.
3. Enter the current SIM PIN.

Important: The default SIM PIN is 0000. Change your PIN to prevent fraudulent use of the SIM Card.

4. Press **Ok** (left softkey).

Entering the PIN

1. Press and hold  to turn on your phone.
2. When the **SIM PIN** screen appears, enter your SIM PIN and press **Ok** (left softkey).

Important: If you enter your PIN incorrectly three times, your SIM card is blocked. See “**Unlocking the PIN**” on page 90.

Changing the PIN

Note: SIM PIN must be turned on in order to access this feature.

1. Press  > **Settings** > **Security** > **Change Passwords** > **SIM PIN**.
2. Enter the current SIM PIN and press **Ok** (left softkey).
3. Enter the new SIM PIN and press **Ok** (left softkey).
4. Reenter the new SIM PIN to confirm and then press **Ok** (left softkey).

Unlocking the PIN

If you enter your PIN incorrectly three times, your SIM card is blocked. To unblock your SIM card, you must contact Nextel Customer Service to get a PIN Unblock

Code (PUK). Follow their instructions for unblocking your SIM PIN.

Important: If you unsuccessfully enter the PUK code ten times, your SIM card is permanently blocked and must be replaced. If this happens, you get a message to contact Nextel Customer Service. Except for making emergency calls, your phone does not function with a blocked SIM card.

Your Phone's Lock Feature

Locking Your Phone

When your phone is locked, you can only make calls to 911. To lock and unlock your phone, you must enter your phone's four-digit lock code. If you do not know your phone's lock code, try 0000; if this does not work contact Nextel Customer Service for assistance.

1. Press  > **Settings** > **Security**.
2. Select **Phone Lock** > **Lock Now**, enter the unlock code, and press **Ok** (left softkey). (To set your phone to lock the next time it is turned on, select **Auto Lock**.)

Unlocking Your Phone



- ▶ At the “Enter Unlock Code” prompt, enter your unlock code and press **Ok** (left softkey).

Changing the Lock Code

1. Press  > **Settings** > **Security** > **Change Passwords**.
2. Select **Unlock Code** then enter your current unlock code and press **Ok** (left softkey).
3. Enter and reenter your new lock code, pressing **Ok** (left softkey) after each.





Calling in Lock Mode

You can place calls to 911 when in lock mode.

- ▶ To call an emergency number, dial  and press .

Locking Your Keypad

When your phone is closed and in standby mode, your keypad locks to prevent accidental key presses.

- ▶ To lock your keypad now, press  > **Settings** > **Security** > **Keypad Lock** > **Lock Now**, or press  .
- ▶ To change how long your phone waits before it automatically locks your keypad, press  > **Settings** > **Security** > **Keypad Lock** > **Auto Lock** and select a time interval of **30 seconds**, **1 minute**, **5 minutes**, **10 minutes**, **15 minutes**, **20 minutes**, or **Off**.

Note: If the keypad setting is set to **off**, your keypad will remain unlocked.

Unlocking Your Keypad

- ▶ To unlock your keypad, press  .

7. Recent Calls

- ◆ About Recent Calls (page 92)
- ◆ Viewing Recent Calls (page 94)
- ◆ Recent Calls Options (page 94)
- ◆ Saving Items From Recent Calls (page 95)
- ◆ Deleting Items From Recent Calls (page 95)
- ◆ Prepending a Number From Recent Calls (page 96)

About Recent Calls

The Recent Calls list displays the last 20 numbers (or Contacts entries) for calls you placed, accepted, or missed, and for Call Alerts you have received. It also displays My Info and contact information sent to you from other phones. It is continually updated as new numbers are added to the beginning of the list and the oldest entries are removed from the bottom of the list.

Duplicate calls (same number and type of call) may only appear once on the list.

When you select a call to view its details, you see information such as the name associated with the call, the number, date, time, and duration of the call.

Note: The Recent Calls list records only calls that occur while the phone is turned on. If a call is received while your phone is turned off, it will not be included in the phone's Recent Calls list.

If you return a call from the voicemail menu, it will not be included in your phone's Recent Calls list.

Calls and Call Alerts



If the number of a recent call is stored in Contacts, the following information appears:

- The name assigned to the number.
- The Contacts type icon associated with the number. If the item contains more than one number or address stored, ◀ ▶ surrounds the Contacts type icon.

The Direct Connect number Contacts type icon appears when you receive a Direct Connect call or Call Alert, even if the number is not stored in Contacts.

Call Alerts you have received appear as Direct Connect calls. Like all items in the Recent Calls list, they remain listed until you delete them or until they reach the end of the list.

For phone calls, an additional icon appears giving information about the call.

-  A call you made.
-  A call you received.
-  A missed call. Missed calls appear on the Recent Calls list only if you have Caller ID.

When you select a call to view its details, you see information such as the name associated with the call, the number, date, time, and duration of the call.

My Info From Other Phones

The Recent Calls list displays My Info sent from other phones. See “Sending My Info and Contact Information” on page 36.

This icon  appears with My Info sent from other phones, along with the Direct Connect number of the person who sent the information.

When you select My Info from other phones to view its details, you see all the information sent.

If you receive My Info from the same phone more than once, only the most recently sent version appears in the Recent Calls list.

Contact Information From Other Phones

The Recent Calls list displays contact information sent from other phones. This information comes from the other phone’s Contacts list or Recent Calls list. See “Sending My Info and Contact Information” on page 36.

This icon  appears with contact information on the Recent Calls list.

Contact information in the Recent Calls list displays:

- The name contained in the contact information.
- The Contacts type icon associated with the number or address contained in the contact information. If the item contains more than one number or address stored,  surrounds the Contacts type icon.

The name or Direct Connect number of the person who sent the contact information appears as a



separate item on the Recent Calls list, above the information sent. If one person sends you more than one item of contact information, all the items appear below the person's name or Direct Connect number.

When you select contact information to view its details, you see the name or Direct Connect number of the person who sent the information and all the information in the item.

If you receive contact information with the same name from the same phone more than once, only the most recently sent version appears in the Recent Calls list.

Viewing Recent Calls



To view the Recent Calls list:

1. Press  or  > **Recent Calls**.
2. Scroll through the list.

To view the details of an item on the list:

- ▶ From the Recent Calls list, highlight an entry and press .

Recent Calls Options

Select a Recent Calls entry and press  to display the date and time of the call, the phone number (if available), and the caller's name (if the number is already in your Contacts). Press  to display the following options:

- **Use Push To...** to select **Send My Info** or **Send Contact** (Direct Connect or Calls Alerts only).
- **Send Contact** to send the contact information to another Direct Connect user.
- **Delete** to delete the entry.
- **Delete All** to delete all recent calls entries.
- **Add Prepend** to prepend a number to the contact number. See "Prepending a Number From Recent Calls" on page 96.
- **Recent Calls View** to select between List View or Picture View.
- **Call Alert Queue** to view the call alert list.
- **Call Setup** to configure the call.
- **Call New Group** to create a Group and place a Group Connect call (Direct Connect or Call Alerts only).

Tip: Press **Create** (left softkey) to begin a message to the highlighted entry.

You can also view the next Recent Calls entry by pressing the navigation key right or view the previous entry by pressing the navigation key left.

Saving Items From Recent Calls

1. From Recent Calls, highlight or select an item.
2. Press **Save** (left softkey).

– or –

If **Save** is not one of your options, press  and then select **Save** or **Update Contacts**.

Tip: If the item you are storing is a call, **Save** does not appear if the number is already stored in Contacts.



3. Select **[New Contact]** to store the number in a new Contacts entry, or select an entry to store the number to an existing entry.

Note: Storing My Info or contact information from another phone to a Contacts entry that has a name assigned to it does not change the name of the Contacts entry.



4. If the item is a call, you must assign a Contacts type to the number:
With the Contacts type field highlighted, scroll left or right to display a Contacts type.
5. To add more information to the entry (optional), follow the applicable instructions in “Creating Contacts Entries” on page 98.
6. Press **Save** (left softkey).

Deleting Items From Recent Calls

To delete an item from the Recent Calls list:



1. From Recent Calls, highlight or select an item.
2. Press  > **Delete**.
3. Press  or press **Yes** (left softkey) to confirm.

To delete all items on the Recent calls list:

1. Press  > **Recent Calls**.
2. Press  > **Delete All**.
3. Press **Yes** (left softkey) to confirm. Press **No** (right softkey) to cancel.

Prepending a Number From Recent Calls

If you need to make a call from the Recent Calls List and you are outside your local area code, you can add the appropriate prefix by prepending the number.

1. Highlight or select a Recent Calls entry and press  > **Add Prepend**.
2. Enter the prefix and press  to call the number.

8. *Contacts*

- ◆ About Contacts (page 97)
- ◆ Creating Contacts Entries (page 98)
- ◆ Viewing Contacts (page 100)
- ◆ Adding a Number to an Entry (page 101)
- ◆ Editing Entries (page 101)
- ◆ Deleting Entries (page 102)
- ◆ Assigning Speed Dial Numbers (page 102)
- ◆ Selecting a Ringer Type for an Entry (page 103)
- ◆ Assigning a Picture to an Entry (page 103)

About Contacts

Contacts stores up to 600 numbers or addresses. Each Contacts entry can store several numbers or addresses.













Information stored in Contacts is saved on your SIM card.

A Contacts entry contains:

- A name — A name is required if you are storing more than one number or address to the entry; otherwise, it is optional. Typically, this is the name of the person whose contact information is stored in the entry.
- A ring tone — You can assign a ring tone to each entry. This is the sound your phone makes when you receive phone calls or call alerts from any of the numbers stored in the entry.
- A Contacts type — Each number or address stored must be assigned a Contacts type. (See “Types of Contacts” on page 98.)

Types of Contacts

Each number or address stored must be assigned a Contacts type:

	Mobile	phone number
	DC	Direct Connect number
	Work1	phone number
	Work2	phone number
	Home	phone number
	Email	email address
	Fax	phone number
	Pager	phone number
	Talkgroup	Talkgroup number
	Group	Group
	IP	IP address
	Other	phone number

Creating Contacts Entries

Each Contacts entry can store up to 10 numbers or addresses, and an entry's name can contain 20 characters.

Tip: ICE – In Case of Emergency

To make it easier for emergency personnel to identify important contacts, you can list your local emergency contacts under "ICE" in your phone's Contacts list. For example, if your mother is your primary emergency contact, list her as "ICE-Mom" in your Contacts list. To list more than one emergency contact, use "ICE1-___," "ICE2-___," etc.

A number or address and a Contacts type are required for all Contacts entries. Other information is optional. You may enter the information in any order by scrolling through the entry details.

After you have entered the number or address, Contacts type, and any other optional information, press **Save** (left softkey) to save the entry to Contacts.

To cancel a Contacts entry at any time press **Cancel** (right softkey) and then press **Yes** (left softkey) to return to the Contacts list or press  to return to standby mode.

To create a Contacts entry:

1. Press **[☰]** > **Contacts** > **[New Contact]**.
2. To assign a name to the entry:
 - Select **Name**. Enter the name and press **[OK]**.
3. To assign a ring tone or picture to the name (optional):
 - Select **Ring Tone/Picture**, select a ring tone or picture, and then press **Back** (right softkey).
4. To assign a Contacts type to the number or address being stored:
 - Highlight the Contacts type field.
 - Scroll left or right to select a Contacts type (**Mobile, DC, Work1, Work2, Home, Email, Fax, Pager, Talkgroup, Group, IP** or **Other**).
5. To store a number or address:
 - Select the **#** field (or ID for an email address, or IP for an IP address).
 - Enter the number or address. For phone numbers, use the ten-digit format. For Direct Connect numbers, be sure to include the asterisks (*).
 - For email addresses, see “Entering Text” on page 16.
 - When you are finished, press **[OK]**.
6. To assign more options to the number, including **Speed #** and **Voice Name**, select **[Options]** and proceed to steps 7-9. Otherwise, skip to step 10.
7. The default Speed Dial number assigned to a phone number is displayed in the **Speed #** field. This is always the next available Speed Dial location. To assign the phone number to a different Speed Dial location:
 - With the **Speed #** field highlighted, press **[OK]**.
 - Press **Delete** (right softkey) to delete the current Speed Dial number.
 - Enter the new Speed Dial number and press **[OK]**.
8. To create a voice name for a number, select **Voice Name**. Follow the prompts to record a name. Speak clearly into the microphone.
9. When you are finished, press **Back** (right softkey).
10. To add more numbers or addresses to the entry:
 - Scroll past the information you already entered.

- Enter the additional information for the entry using steps 2–9. You must assign a name to the entry, if you have not already.

11. Press **Save** (left softkey).

Creating Pauses and Waits

When storing a number, you can program your phone to pause or wait between digits while dialing. A pause makes your phone pause for three seconds before dialing further. A wait makes your phone wait for your response before dialing further.

This feature is useful when using voicemail or other automated phone systems that require you to dial a phone number and then enter an access number.

For details on using pauses and waits, see “Phone Numbers With Pauses” on page 26.



Storing Numbers Faster

To store numbers to Contacts from standby mode:

1. Enter a phone number or Direct Connect number.
2. Press  > **Store Number**.

3. Select **[New Contact]** to store the number to a new entry, or select an entry to store it to an existing entry.
4. With the Contacts type field highlighted, scroll left or right to select a Contacts type.
5. To add more information to the entry, follow the applicable instructions in “Creating Contacts Entries” on page 98.
6. Press **Save** (left softkey).

Viewing Contacts

1. Press  > **Contacts** and then either highlight an entry, enter the first letter of a name, or press **Search** (left softkey), and enter a name. (Your phone finds the name you entered or the nearest match.)
2. If an entry has more than one number or address stored,  surrounds the Contacts type icon. Scroll left or right to view the icon for each number stored in the entry.
3. Press  to display the entry, and then scroll up or down to view all information stored for the entry.

Tip: To display the next or previous entry, scroll right or left.

Filtering Contacts Entries

You can set Contacts to display only entries containing Direct Connect numbers, Groups, and Talkgroups.

- ▶ Press **[Menu]** > **Contacts** > **[Menu]** > **Filter** > **Show DC**.
Select **Show All** to display all Contacts entries.

Finding Speed Dial Numbers

- ▶ Press **[Menu]** > **Contacts**, select an entry and select a phone number. The speed dial number is listed directly under the contact phone number.

Adding a Number to an Entry

1. Display a Contacts entry. (See “Viewing Contacts” on page 100.)
2. Press **Edit** (left softkey) or **[Menu]** > **Edit**.
3. Highlight the number type field above an open number and press the navigation key right or left to select a number type.

4. Scroll down to the open field, enter the new number or address and press **[OK]**.
5. Press **Save** (left softkey) to save the new number.
– or –



To assign a speed dial number or Voice Name, select **[Options]** > **Speed #** or **Voice Name**. Complete the process, press **Back** (right softkey) and then press **Save** (left softkey) to save the entry.

Editing Entries



1. Press **[Menu]** > **Contacts** and highlight an entry.
2. Press **Edit** (left softkey) or **[Menu]** > **Edit**.
3. Follow the applicable instructions in “Creating Contacts Entries” on page 98 to edit the entry.

Tip: When editing or adding to entries, make sure to press **Save** (left softkey) to save the changes (you may have to press **Back** to display the **Save** option). If you press **[Menu]** before pressing **Save**, your changes will be discarded.

Deleting Entries

1. Press  > **Contacts** and highlight an entry.
2. Press  > **Delete Contact**.
3. Press  or press **Yes** (left softkey) to confirm.

Deleting a Number or Address

1. Press  > **Contacts** and highlight an entry.
2. Scroll left or right to display the Contacts type to delete.
3. Press  > **Delete Number**.
4. Press  and **Yes** (left softkey) to confirm.



Note: If an entry contains only one number or address, deleting the number or address deletes the entry.

Assigning Speed Dial Numbers



Your phone can store up to 600 phone numbers in speed dial locations. (For details on how to make calls using speed dial numbers, see “Speed Dialing” on page 27.)

You can assign speed dial numbers when you add a new Contacts entry, when you add a new phone number to an existing entry, or when you edit an existing number.

To assign a speed dial number to a new phone number:

1. Add a phone number to a new or to an existing Contacts entry. (See “Creating Contacts Entries” on page 98 or “Adding a Number to an Entry” on page 101.)
2. Highlight **[Options]**, press , and then select **Speed #**.
3. Enter an available speed dial number and press .
4. Press **Back** (right softkey) and then press **Save** (left softkey) to save the entry.

To assign a speed dial number to an existing phone number:

1. Press  > **Contacts** and then highlight an entry.
2. Press **Edit** (left softkey) or  > **Edit**.
3. Select **[Options]** below the number, and then select **Speed #**.

4. Enter an available speed dial number and press **OK**.
5. Press **Back** (right softkey) and then press **Save** (left softkey) to save the changes.

Note: If you attempt to assign an already in-use speed dial location to a new phone number, a message will appear asking if you wish to overwrite the existing speed dial assignment. Press **Yes** (left softkey) to assign the location to the new phone number and delete the previous speed dial assignment.

Selecting a Ringer Type for an Entry

Assign a ringer type to a Contacts entry so you can identify the caller by the ringer type. (See “Ring Tones” on page 69.)

1. Press **☰** > **Contacts** and then highlight an entry.
2. Press **Edit** (left softkey) or **☰** > **Edit**.
3. Select **[Ringtone/Picture] > Ringer**.
4. Scroll through available ringers. (When you highlight a ringer type, a sample ringer will sound.)
5. Press **OK** to select a ringer.

6. Press **Back** (right softkey) and then press **Save** (left softkey) to save the assigned ringer.

Assigning a Picture to an Entry

Assign a picture to display when you receive a call from an entry.

1. Press **☰** > **Contacts** and then highlight an entry.
2. Press **Edit** (left softkey) or **☰** > **Edit**.
3. Select **[Ringtone/Picture] > Picture**.
4. Scroll through available pictures and press **OK** to select one. (Scroll left or right to browse pictures in the phone’s memory or on the memory card.)
5. Press **Back** (right softkey) and then press **Save** (left softkey).

9. Tools

- ◆ Datebook (page 104)
- ◆ My Info (page 109)
- ◆ Java Applications (page 110)
- ◆ Digital Rights Management (DRM) (page 111)
- ◆ GPS Enabled (page 113)
- ◆ Memo Feature (page 117)
- ◆ Voice Records (page 118)
- ◆ Call Timers (page 120)

Datebook

Datebook stores up to 250 events. You can store events over a thirteen month period – twelve months after and one month before the current date.

A Datebook event contains:

- A subject – A name or number you assign to the event.
- A location – The location of the event. This can also be a phone number, Direct Connect number, or Talkgroup.
- A start time – The start time for the event. Default is the beginning of the day.
- A duration – The length of time the event lasts.
- A date – The date for the event. Default is the day highlighted when the event is created.
- A repeat – For recurring events.
- A reminder – A scheduled alert for events that include a start time.
- A ring tone for the reminder.
- A profile that your phone uses during the event.
- A Java application that starts when the event starts.

Only subject and date are required to save an event.

Viewing Datebook

- ▶ Press  > **Tools** > **Datebook**.

You can view Datebook by the day, by the week, or by the month. You can also view the details of any event.

- In day view, brief information about each event for that day appears.
- In week view, events appear as markers corresponding to their times.
- In month view, days with events are marked.

To view an event:

1. Select the day the event occurs.
2. Select the event.

To change the current view:

- ▶ While in Datebook, press  and select a view.

Note: Day view is the default setting.

Navigating Datebook

To scroll through Datebook:

- ▶ Scroll left and right using the navigation key.
- or –

In week view and month view, press  or .

To see more in day view:

- ▶ Scroll up and down using the navigation key.

To highlight a day in month view:

- ▶ Enter the date using the keypad.

To go to today's date:

- ▶ While in Datebook, press  > **Go To Today**.

To go to any date in Datebook:

1. While in Datebook, press  > **Go To Date**.
2. Select a date.

Creating Events

Every Datebook event must have a subject and be stored to a date. Other information is optional.

After you have entered the information, press **Done** (left softkey) to store the event to Datebook.

To create a Datebook event:

1. While in datebook, press **New** (left softkey).
- or –
- In day view, select **[New Event]**.

2. To assign a subject to the event, select **Subject** and:
 - Enter the name or enter a phone number, Direct Connect number, or Talkgroup number.
 - or –Press **Browse** (left softkey) to choose from common event names.
3. To assign a location to the event (optional), select **Location** and enter the location or enter a phone number, Direct Connect number, or Talkgroup number.
4. The start time automatically assigned to an event is the beginning of the day. To change the start time or assign no start time, select **Start** and then enter a start time or press **No Time** (left softkey).
5. To assign a duration, select **Duration** and select a duration from the list or select **Custom** and enter a duration.
6. The date automatically assigned to an event is the date that was highlighted or selected when you began creating the event. To change the date of the event, select **Date** and then enter a date.

7. To make the event a recurring event:
 - Select **Repeat** and then select a repeat cycle.
 - If the event occurs more than once a week, select **Multiple Day**, and select the days.
 - Press **Done** (left softkey).
 - In the **End** field, select a date for the event to stop recurring.
8. To create a reminder for this event, select **Reminder** and then select a reminder time or select **Custom** to enter a reminder time.

Note: If an event has no start time, you cannot create a reminder for it.

9. To set the ring tone for a reminder, select **Ring Tone** and then select a ring tone.
10. To assign a profile for your phone to use during the event, select **Profile** and then select a profile. (Your phone switches to this profile when the event starts and switches back to the previous profile when the event ends.)
11. To assign a Java application to start when the event starts, select **App** and then select an application. (If you created a reminder for this

event, your phone prompts you to start the Java application when you get the reminder.)

12. Once you have entered all relevant information and settings, press **Done** (left softkey).

To cancel without saving:



- ▶ Press **Cancel** (right softkey).

Editing Events

To change the details of an event:



1. Select the day the event occurs.
2. Select the event and press **Edit** (left softkey).
3. Follow the applicable instructions in “Creating Events” on page 105 to edit the event.

To copy an event to another date:

1. Select the day the event occurs.
2. Select the event and press  > **Copy**.
3. Press **Yes** (left softkey) to confirm.
4. Enter a date and press .

5. To change more information, follow the applicable instructions in “Creating Events” on page 105 to edit the event.
6. Press **Done** (left softkey) to store the event.

Deleting Events

1. Select the day the event occurs.
2. Select the event and press  > **Delete**.
3. If the event is not a recurring event, press  or press **Yes** (left softkey) to confirm.

– or –

If the event is a recurring event, select **This Event Only** to delete only the event selected in step 2, or select **Repeat Event** to delete all occurrences of the event.

Receiving Reminders

If you created a reminder for a Datebook event, when the reminder time occurs, your phone notifies you with text on the display and a reminder tone.

To view more details about the event:

- ▶ Press **View** (left softkey).

To dismiss the reminder:

- ▶ Press **Dismiss** (right softkey).

For Events With Java Applications

If you assigned a Java application to start when the event starts, you can start the application when you get the reminder.

- ▶ Press  > **Launch**.



Making Calls From Datebook and Datebook Reminders

If you stored a phone number, Direct Connect number, or Talkgroup number in the **Subject** or **Location** field of a Datebook event, you can call or send a Call Alert to that number from Datebook or from the reminder.



If you store the same type of number (phone number or DC/Talkgroup number) in both fields, the number in **Subject** takes precedence.

Making Calls From Datebook

To make a phone call:

1. Highlight or select an event containing a phone number.
2. Press  or press  > **Call # in Event**.

To make a Direct Connect call or Talkgroup call:

1. Highlight or select an event containing a Direct Connect or Talk Group number.
2. Press the DC button. (If you did not include a  before a Talkgroup, press  > **Talkgroup**, and then press the DC button.)

To send a Call Alert:

1. Highlight or select an event containing a Direct Connect number.
2. Press  > **Alert # in Event**, and then press the DC button.

Making Calls From Datebook Reminders

To call a number:

- ▶ Press or press and then select **Call # in Event**.

To make Direct Connect calls or Talkgroup calls:

- ▶ Press the DC button.

To send a Call Alert:

- ▶ Press > **Alert # in Event**, and then press the DC button.

Customizing Datebook Setup

1. Select > **Tools** > **Datebook** > > **Setup**.
2. Select an option and adjust the values.
 - Options include **Start View**, **Daily Begin**, **Delete After**, **Time Shift**, **Alert Timeout** and **Clock**.

My Info

My Info lets you view your phone number, Direct Connect number, and other phone information.

- ▶ Press > **Tools** > **My Info**.
 - Information displayed includes **My Name** (optional, you may enter it yourself), **Line 1**, **Line 2**, **Direct Connect**, **Group ID** (Talkgroup number), **Carrier IP**, **IP1 Address** and **IP2 Address**.

Note: If you request equipment-related transactions on your account, Nextel Customer Service may require you to provide specific information about your phone. Press while in My Info to display a submenu that includes your phone's service status, unit information, and phone identification numbers including IMEI, SIM ID, and Serial Number (SN).

Adding a Name to My Info

1. Press > **Tools** > **My Info**.
2. Press **Edit** (left softkey) > **Name**.
3. Enter a name and press .

You can also edit the information in **Line 1** and **Line 2**, but your changes are only temporary. The next time your phone registers on the network, your actual phone numbers appear again in My Info.

Java Applications

Installing Applications

1. Press  > **Games and Apps**.
2. Select an application or suite of applications. Messages appear as the application installs.
3. Press **Done** (left softkey).

Running Applications

1. Press  > **Games and Apps**.
2. Select an application or suite of applications. If you have selected a suite of applications, select an application.

Tip: If you do not hear the sounds associated with the Java application, select **Settings > Volume** and check the volumes of **Speaker** and **Earpiece**.

Suspending Applications

When you suspend an application, it does not stop running. It goes to the background so that you can run another application in the foreground.

To suspend an application:

- ▶ Press .

To view your suspended applications:

- ▶ Press  > **Games and Apps > Suspended Apps**.

You can have up to three applications running at one time – one running in the foreground and two in the background.

Resuming Applications

You can resume a suspended application at any time. This brings it to the foreground.

To resume a suspended application:

1. Press  > **Games and Apps > Suspended Apps**.
2. Select an application to resume.

Ending Applications

To end an application:

- ▶ Press the appropriate softkey to end or exit the application or press  > **End**.

To end an application from the Suspended Apps Screen:

1. Press **Games and Apps > Suspended Apps**.
2. Highlight an application and press **End** (left softkey).

To end all applications:

1. Press **Games and Apps > Suspended Apps > End All**.
2. Press **OK** or press **Yes** (left softkey) to confirm.
3. To end all applications without letting them exit, press **EndNow** (left softkey) and then press **Finish** (right softkey).

Downloading Applications

To run more Java applications, you can download them into your phone.

To access a catalog of items available for purchase and download:

- ▶ Press **Games and Apps > Buy Games&Apps**.

You can also go to www.nextel.com and sign on to your account to find a wide selection of available Java applications and downloading instructions.

Deleting Applications

To delete an application:

1. Press **Games and Apps**.
2. Highlight an application and press **Deinstall**.
3. Press **OK** or **Yes** (left softkey) to confirm.
4. When your phone has finished deleting the application, press **Done** (left softkey).

To delete all Java applications:

1. Press **Games and Apps**.
2. Highlight **Java System** and press **Delete All**. (You may need to press **More** [left softkey] to display **Java System**.)
3. Press **OK** or press **Yes** (left softkey) to confirm.

Digital Rights Management (DRM)

When you download multimedia content available online, such as Java applications, these items may be subject to DRM restrictions. DRM, or digital rights

management, is a system that defines how copyrighted multimedia content can be distributed and used.

DRM limits items to time-based or count-based usage settings. Time-based settings let you use the given item for a specified interval. Count-based settings let you use an item for a specified number of times after you download it or for unlimited use.

Managing Items

Depending on how the third-party vendor has set rights for the given DRM item, you may be unable to perform some of the following tasks.

Viewing License Information

You can check a DRM item's license to view the following information:

- For time-based items, either the date and time the item expires, or the number of days left.
- For count-based items, the number of credits (uses) left or an unlimited use notice.
- The name of the item's vendor.

To view the license of a DRM item:

1. Go to the location that contains the item.
2. Highlight the item and press  > **License Info**.

Renewing DRM Licenses

Note: Java application data is stored in your phone using the same memory space used to store messages, voice records, pictures, ring tones, and wallpaper images. Deleting some of these other items frees memory for Java applications.

1. Go to the location on your phone that contains the item.
2. Highlight a DRM item and press **Renew** (left softkey) or press  > **Renew**.
3. Select the link to the page where you purchased the item and then follow the vendor's instructions for purchasing an additional license.

Deleting Items

If you delete a DRM item that you purchased from Nextel from your phone, you will have to purchase it again to download it.

Note: You cannot delete items that are DRM locked.

Under certain conditions, third-party vendors will let you download an item multiple times within a given time frame, even if you deleted the item. Please contact the third-party vendor of an item to learn more about the vendor's download regulations.

1. Highlight a DRM item and press  > **Delete**.
2. If prompted, press **Yes** (left softkey).

About Expired Items

Most items will continue to display on your phone until you delete them. You can also choose to renew the license for an expired item.

GPS Enabled

Your phone's GPS Enabled feature uses information from Global Positioning System (GPS) satellites orbiting the Earth to determine the approximate geographical location of your phone. The availability and accuracy of this location information (and the amount of time that it

takes to calculate it) will vary depending on the environment in which you are using the GPS feature.

When you make a 911 emergency call, the GPS feature of your phone can help emergency personnel locate you if your phone has adequate access to GPS satellite signals and your emergency response center is equipped to process such information.

You can also use the GPS feature to view your approximate location. Location information appears on the phone's display.

Java applications loaded on your phone can also request your location. If your phone is connected to a laptop computer or similar device, software running on that device can request your location. To protect your privacy, you can control whether these requests are granted. See "GPS Privacy Options" on page 86.

IMPORTANT: Things to Keep in Mind

If you are using the GPS feature of your phone while driving, please give full attention to driving and to the road.

Where adequate signals from multiple satellites are not available (usually because your GPS antenna cannot

establish a view of a wide area of open sky, such as in underground locations, inside or between buildings, or in dense tree cover), the GPS feature of your phone WILL NOT WORK.

Walking or driving very slowly may also substantially reduce GPS performance.

Making an Emergency Call

- ▶ Dial **911** and press  to be connected to an emergency response center. If you are on an active call, you must end it before calling 911.

When you make an emergency 911 call, the GPS feature of your phone begins to calculate your approximate location. Even where your phone has good access to sufficient GPS satellite signals and network assist data, it may take 30 seconds or more to determine the approximate location. This time will increase where there is reduced access to satellite signals. When your approximate location is determined, it is made available to the appropriate emergency response center.

In some cases, your local 911 emergency response center may not be equipped to receive GPS location

information. For this reason, and because the GPS location information reported is only approximate or may not be available in your location, always report your location to the 911 operator you speak to when making an emergency call, if able, just as you would when using a phone without GPS capabilities.

Note: If you are concerned about whether your local 911 emergency response center is equipped to receive GPS location information, contact your local authorities.

Viewing Your Approximate Location

- ▶ Press  > **Tools** > **GPS** > **Position**.

This displays the following information about the last time your location was calculated:

- The time (as Greenwich Mean Time) and date that the location was last calculated.
- The approximate location, expressed as latitude and longitude.
- The estimated accuracy of the calculated location.
- The number of satellites used to calculate the location. In general, more satellites make for better accuracy.

To calculate your location again:

- ▶ Press **Refresh** (left softkey).

It may take your phone several minutes to complete the process of determining your location, during which the phone displays “Scanning For Satellites.”

The Position screen displays the updated information.

To cancel a location calculation before it is completed:

- ▶ Press **Cancel** (right softkey) to return to the Position screen or press  to return to standby mode.

Each time approximate location of your phone is calculated, the latest location information is stored in your phone. You will see this information the next time you view the Position screen.

Enhancing GPS Performance

Sometimes the GPS feature of your phone may be unable to complete a location calculation successfully.

To improve accuracy and increase your chances of a successful calculation, do the following while your phone is determining your approximate location:

- **Stay in the open.** The GPS feature works best where there is nothing between your phone and a large amount of open sky. If possible, go outside, away from tall buildings and foliage.
- **Hold your phone to enhance reception.** Signals from GPS satellites are transmitted to your GPS antenna, which is in your phone antenna. Hold your phone away from your body, giving the antenna clear access to satellite signals. Do not cover the antenna area with your fingers or anything else.
- **Stand still.** If possible, stand still until your phone is finished determining your location. Moving your phone at a walking pace while your phone is calculating your approximate location may substantially decrease GPS performance.
- **In a car.** When using the GPS Enabled feature in a car, position your phone so that the GPS antenna has good access to GPS signals through the car's windows. Typically, the GPS antenna has best access to GPS signals in a car when placed near a window.

Note: Although moving your phone at a walking pace decreases GPS performance, moving it at the speed of a moving car does not.

- **Stay in network coverage.** The network will provide your phone with information that helps determine your location more quickly and accurately.

Using GPS With Map Software

You can use the GPS feature of your phone to provide approximate location data to a laptop computer or similar device that is running interactive map software such as that made by DeLorme or Microsoft. This way, if your phone has good access to GPS signals, your approximate position on a map can be made available as you travel in a vehicle.

To do this, connect your phone to your laptop (or other device) with a data cable and set your phone to transmit data (see “To connect your phone to your laptop or other device:” on page 116). Your phone then provides your approximate location to the device running the map software, which displays your location on a map. Your phone provides an updated location every second and the map software displays your changing location on its map.

See “Enhancing GPS Performance” on page 115 for more details on obtaining good location information.

Note: Because your phone is continuously determining your location, using the GPS feature of your phone with map software uses the phone’s battery power quickly.

To connect your phone to your laptop or other device:

1. Pull open the connector cover.
2. With the phone’s display facing up, insert a micro-USB data cable into the charger connector.

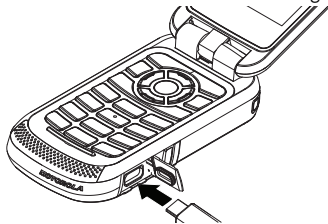

3. Insert the data plug into the COM port of your laptop or other device.

Make sure no other application is using the COM port selected.

Make sure the COM port settings of your laptop or other device are set to the following:

- Bits per second: 4800
- Data bits: 8
- Parity: None
- Stop bits: 1
- Flow control: Hardware

To set your phone to send location information to your laptop or other device:

1. Press  > **Tools** > **GPS** > **Interface**.
2. Set **NMEA OUT** to **USB** or **Bluetooth**.

Your phone is now sending location data to your laptop or other device.

To stop sending location data to your laptop or other device:



- ▶ Set **NMEA OUT** to **Off**.

Each time you power your phone on, **NMEA OUT** is automatically set to **Off**.

Memo Feature

Memo lets you store a number, make a call to that number, and save it to Contacts.



To create a memo:

1. Press  > **Tools** > **Memo**.
2. Enter a number and press .

To view the memo later:

- ▶ Press  > **Tools** > **Memo**.



To delete the memo:

1. Press  > **Tools** > **Memo**.
2. Press and hold **Delete** (left softkey) and then press .



To edit the memo:

1. Press  > **Tools** > **Memo**.
2. Press and hold **Delete** (left softkey) to delete the number.
3. Enter the new number and press .

To make a call to the memo number:

1. Press  > **Tools** > **Memo**.
2. To make a phone call, press . To make a Direct Connect call, press the DC button.

To store the memo number to Contacts:



1. Press  > **Tools** > **Memo**.
2. Press  > **Store to Contacts**.
3. To store the number as a new entry, select **[New Contact]**.
– or –
To store the number to an existing entry, select the entry.
4. With the Contacts type field highlighted, scroll left or right to display a Contacts type for the number.
5. To add more information to the entry, follow the applicable instructions in “Creating Contacts Entries” on page 98.
6. Press **Save** (left softkey).

Voice Records



A voice record is a recording you make with your phone and can play back. You can record notes to yourself or phone calls.

Your phone can store up to 20 voice records.

Creating Voice Records



1. Press  > **Multimedia** > **VoiceRecord** > **[New VoiceRec]**.
2. Recite a message into the microphone.
3. When you are finished recording, press .

To record a phone call:

1. While on an active call, press  > **Record**.
2. When you are finished recording, press .

Note: Recording of phone calls is subject to applicable laws regarding privacy and recording of phone conversations.

Playing Voice Records

1. Press  > **Multimedia** > **VoiceRecord**.
2. Highlight a voice record and press .
3. To stop the voice record while it is playing, press .

Tip: To fast forward, scroll right. To rewind, scroll left. To pause or resume, press any number key.



Labeling Voice Records

When you create a voice record, it is labeled with the time and date it was recorded. You can rename it with a custom label.



1. Press  > **VoiceRecord**.
2. Highlight a record and press **Label** (left softkey).
3. Enter a label and press .

Deleting Voice Records

To delete an unlocked voice record:



1. Press  > **Multimedia** > **VoiceRecord**.
2. Highlight a record and press  > **Delete**.
3. Press  or **Yes** (left softkey) to confirm.

To delete all unlocked voice records:

1. Press  > **Multimedia** > **VoiceRecord**.
2. Highlight a record and press  > **Delete All**.
3. Press  or **Yes** (left softkey) to confirm.

Locking Voice Records

When you lock a voice record, it cannot be deleted until you unlock it.

1. Press  > **Multimedia** > **VoiceRecord**.
2. Highlight a record and press  > **Lock** to lock it. Press  > **UnLock** to unlock a message.

When a voice record is locked, this icon  appears next to it.

Managing Memory

To view the amount of memory available for voice records:

1. Press **[Menu]** > **Multimedia** > **VoiceRecord**.
2. With **[New VoiceRec]** highlighted, press **Memory** (left softkey).

Call Timers

Call timers measure the duration of your phone calls, Direct Connect, or Group Connect calls, and the number of kilobytes sent and received by your phone:

- **Last Call** — displays the duration of your most recent phone call.
- **Phone Reset** — keeps a running total of your phone call minutes, until you reset it.
- **Phone Lifetime** — displays the total minutes of all your phone calls.
- **DC/GC Reset** — keeps a running total of all of your Direct Connect and Group Connect call minutes, until you reset it
- **DC/GC Lifetime** — displays the total minutes of all your Direct Connect and Group Connect calls.

- **Kbytes Reset** — keeps a running total of the number of kilobytes sent and received by your phone, until you reset it.

To view or reset a timer:

1. Press **[Menu]** > **Tools** > **Call Timers**.
2. Select a timer and press **[OK]**.
 - To reset a timer, select **Phone Reset**, **DC/GC Reset**, or **Kbytes Reset** and press **[OK]**. Press **Reset** (left softkey). Press **[OK]** or press **Yes** (left softkey) to confirm.

Note: The values displayed by Call Timers should not be used for billing. Call times are estimates only.

10. microSD Card

- ◆ Using a microSD Card With Your Phone (page 121)
- ◆ microSD Settings (page 123)
- ◆ microSD Folders (page 124)
- ◆ Connecting Your Phone to Your Computer (page 125)

Using a microSD Card With Your Phone

Using the microSD Card Slot

Your phone is equipped with a microSD (Secure Digital) memory card slot to expand the phone's available memory space. It allows you to store images, videos, music, and voice data in your phone.

Inserting the microSD Card

1. Remove the battery cover. (See “Installing the Battery” on page 10.)
2. Open the memory card slot cover, and slide in the memory card until it clicks into place.

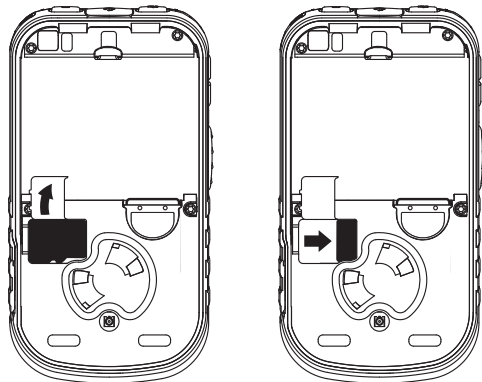

Note: Be sure to use only recommended microSD cards. Using non-recommended microSD cards could cause data loss and damage your phone. Your handset can be used with Transflash or microSD memory cards.

3. Close the memory card slot cover and replace the battery cover.
4. Your phone may prompt you to use the memory card to store new media items, go to Music Player, go to the Camera, go to the Media Center, or do nothing. If you select **[Do Nothing]**, you will return to standby mode. Respond to the prompt now.

Removing the microSD Card

Do not remove the memory card until you select the **Remove Card** option under Settings. Removing the memory card before selecting the **Remove Card** option could result in loss of data.

1. Press **[Menu]** > **Settings** > **Memory Card** > **Remove Card**.
2. Once the handset confirms that it is safe to remove the microSD card, press **OK** (left softkey).
3. Remove the battery cover and open the memory card slot cover.

4. Grasp the raised edge of the microSD card and pull the card out.

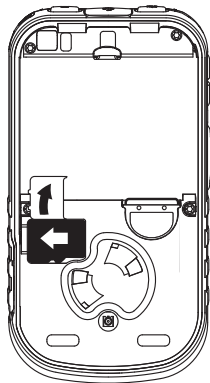

Note: The microSD card and its adapter can be easily damaged by improper operation. Please be careful when inserting, removing, or handling them.

5. Close the memory card slot cover and replace the battery cover.

Using the microSD Adapter

The supplied microSD adapter allows microSD cards to be used in SD-compatible devices such as digital cameras, printers, and computers. Before using, you will need to insert the microSD card into the microSD adapter.

To insert the microSD card into the microSD adapter:

- ▶ With the label side of the microSD card facing up, insert the card into the supplied microSD adapter, and gently slide the card until it is fully inserted.

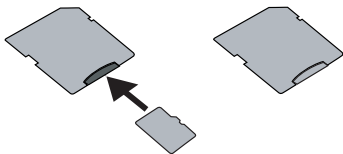

To remove the microSD card from the microSD adapter:



- ▶ Hold the front edge of the microSD card, and gently pull outward to remove it from the adapter.

Tip: If your computer has an SD card slot or if you have an SD card adapter, you can use the microSD card and adapter to transfer files such as audio files, pictures, and videos directly between your computer and your microSD card.

When you insert the card into your computer, select **Open folder to view files using Windows Explorer** (or a similar option) and drag and drop files using the available folders.

microSD Settings

Viewing Memory in the microSD Card

1. With the microSD card inserted, press  > **Multimedia > Media Center >  > Memory Usage.**
2. The following information will be displayed:
 - **Used** displays the amount of used memory space.
 - **Free** displays the amount of free memory space.
 - **Capacity** displays the capacity of the memory card.
 - **Card Files** displays the number of files in the card.

Setting Storage Options

You can set your phone to store pictures, videos, music, and audio recordings on an inserted microSD card instead of in the phone's memory (when available).

1. With the microSD card inserted, press **[Menu]** > **Settings** > **Memory Card** > **Store Media**.
2. To store pictures, videos, music, and audio recordings on the memory card, select **Prefer On Card**.

Formatting the microSD Card

Formatting a microSD card permanently removes all files stored on the card.

1. With the microSD card inserted, press **[Menu]** > **Settings** > **Memory Card**.
2. Select **Format Card** and press **[OK]**. (A warning will be displayed.)
3. If you are sure you wish to remove all the files from your microSD card, press **Yes** (left softkey).

WARNING: The formatting procedure erases all the data on the microSD card, after which the files CANNOT be retrieved. To prevent the loss of important data, please check the contents before you format the card.

microSD Folders

Displaying Your microSD Folders



All the files stored in the appropriate folders on the microSD card are accessible through the Media Center.

1. With the microSD card inserted, press **[Menu]** > **Multimedia** > **Media Center**.
2. Press the navigation key left or right to display a Card folder (**All**, **Pictures**, **Audio**, or **Video**) and press **[OK]**.
3. To view or play a file, select it and press **[OK]** or the appropriate softkey.

Note: The Media Center only recognizes compatible files stored in the card's AUDIO, VIDEO, and IMAGE folders.

Connecting Your Phone to Your Computer

Before using your phone's mass storage capabilities, you need to prepare your phone's data services to synchronize with your desktop or laptop computer. Once the phone is connected to the computer, you can transfer your data to or from the microSD card.

1. With the microSD card inserted, press  > **Settings > Connections > USB**.
2. Highlight **Memory Card Access** and press .

Note: To allow applications to access you phone, press  > **Settings > Connections > USB > Application Access**.

3. Connect your phone to your computer using a compatible USB cable. (Wait for the connection to be completed. When connected, the host computer will automatically detect your phone.)

To remove the connection:

- ▶ When you have finished transferring data, click the USB device icon on your computer's taskbar, and

follow the onscreen instructions to safely unplug the USB cable.

Important Connection Information



- No driver installation is required for Windows 2000/ME/XP/Vista users. If you use Windows 98/98SE, you have to download and install the USB Mass Storage Driver from the Nextel website at www.nextel.com.
- To avoid loss of data, DO NOT remove the USB cable, the microSD card, or the battery while files are being accessed or transferred.
- DO NOT use your computer to change or edit folder or file names on the microSD, and do not attempt to transfer large amounts of data from the computer to the microSD card. Doing so may cause the microSD card to fail.
- DO NOT turn off or restart your computer, or put it into standby mode, while using a mass storage device. Doing so will result in loss or damage of data.
- If you connect a mass storage device to a peripheral device, your device may not work properly.

11. Camera



- ◆ Taking Pictures (page 126)
- ◆ Camera Options (page 127)
- ◆ Recording Videos (page 128)
- ◆ Storing Pictures and Videos (page 130)

Taking Pictures

Taking pictures with your phone's built-in camera is as simple as choosing a subject, pointing the lens, and pressing a button.

1. With the phone open, press  to activate camera mode.
2. Using the display screen as a viewfinder, aim the camera lens at your subject.
3. Press **Capture** (left softkey),  or  until the shutter sounds.

Tip: To take a self-portrait, activate the camera and then close the phone. Use the external screen to aim the lens, and then press the speaker button () to take the picture.

- Press **Send** (left softkey) to send the picture in an MMS message, **Discard** (right softkey) to discard the picture and return to the camera,  to save the picture and return to camera, or press  for the following options:
 - **Send Via...** to send the picture via Direct Send (PTT), Bluetooth, or Messaging (MMS).
 - **Save [OK]** to save the picture.
 - **Set As Caller ID** to assign the picture to a contact. Select a contact and press .
 - **Set As Wallpaper** to use the picture as your phone's wallpaper.
 - **Media Center** to save the picture to the Media Center and open the Media Center.
 - **Remove Card** to enable the memory card removal.
 - **Memory Usage** to see the amount of used and available memory on your phone.

- **Memory Card** to access the memory card menu.
- **Camera Setup** to set the camera default settings for **Ask for Name**, **Shutter Sound**, **Default Size**, **Default Quality** and **GPS Tag**.



Camera Options

With the phone in camera mode, press  to display additional camera options:

- **[Help]** to open a help file.
- **Record Video** to switch to video mode. (See “Recording Videos” on page 128 for details.)
- **Media Center** to go to the Media Center to review your saved pictures.
- **Zoom** to zoom in on a subject. (See “Using the Zoom” on page 128 for details.)
- **Remove Card** to safely remove the memory card.
- **Spotlight** to turn the flash on or off.
- **Self Timer** to activate the camera's timer. (See “Setting the Self Timer” on page 127 for details.)
- **GPS Tag** the option to turn GPS Tag on or off.

- **Picture Quality** to select the picture quality between **Normal** or **Fine**.
- **Picture Size** to select the picture size.
- **White Balance** to select a white balance setting.
- **Exposure Control** to adjust the exposure.
- **Style** to set the picture effect.
- **Memory Usage** to verify memory usage.
- **Memory Card** to access the memory card menu.
- **Camera Setup** to set the camera default settings.

Setting the Self Timer

1. From camera mode, press  > **Self Timer**.
2. Highlight a delay length (**10 seconds**, **15 seconds** or **20 seconds**) and press .
3. Press **Capture** (left softkey) or  when you are ready to start the timer. (The lower portion of the display screen displays the countdown time.)
4. Get ready. The camera will automatically capture the picture when the timer runs down.

To cancel the self timer after it has started:

- ▶ Press **Cancel** (right softkey).

Using the Zoom

Depending on your resolution settings, you can adjust the zoom from 1x to 4x.

To adjust the zoom:

1. While in camera mode, press > > **Zoom**.
2. Select from 1X, 2X or 4X.

Camera Setup

Set your camera's resolution and default size in the Camera Setup menu.

1. Press > > **Camera Setup**.
2. Select an option and press .

 - **Ask for Name:** Select **On** for the camera to prompt you to enter a new file name when saving a picture.
 - **Shutter Sound:** Select an option and press .
 - **Default Size:** Select a size and press .
 - **Default Quality:** Highlight **Normal** or **Fine** and press .
 - **Spotlight Setting:** Allows you to set the spotlight to **Always On**.

- **GPS Tag:** If this option is **On**, pictures will be tagged with the geographic location of where they were taken.

Recording Videos

In addition to taking pictures, you can also record, view, and send videos with the phone's video camera.

To record a video:

1. Press > **Multimedia** > **Camcorder** to activate video mode. (Additional video options are available through the video mode Options menu. See "Video Mode Options" on page 129 for more information.)
2. Using the display screen as a viewfinder, aim the lens at your subject.
3. Press **Record** (left softkey) or to begin recording.
4. Press or **Stop** (left softkey) to stop recording.
 - To return to camcorder mode to take another video, press to save or **Discard** (right softkey) to delete the video.

5. Press  for more options:
 - **Review** to play back the video.
 - **Send Via...** to send the video via Bluetooth or Messaging (MMS).
 - **Save [OK]** to save the video.
 - **Media Center** to go to the Media Center to review your saved videos.
 - **Remove Card** to enable the memory card removal.
 - **Memory Usage** to verify memory usage.
 - **Camera Setup** to set the camcorder default settings.



Video Mode Options

With the phone in video mode, press  to display additional options:

- **Media Center** to go to the Media Center to review your saved videos.
- **Capture Picture** to switch to picture mode.
- **Zoom** to zoom in on a subject.
- **Remove Card** to enable the memory card removal.
- **Spotlight** to turn the spotlight on or off.

- **Video Size** to select the video size.
- **Video Length** to select the video length.
 - **Short (for messages)** restricts the length of the video to a size that can be sent via messaging.
 - **Maximum** lets you take as long a video as available memory space allows.
- **Memory Usage** to verify memory usage.
- **Memory Card** to access the memory card menu.
- **Camera Setup** to set the camcorder default settings.

Selecting Video Settings

1. From video mode, press  > **Camera Setup**.
2. Select an option and press :
 - **Ask for Name:** Select **On** for the camcorder to prompt you to enter a new file name when saving a video file.
 - **Shutter Sound:** Select an option and press .
 - **Default Video Size:** to set a video's default size.
 - **Spotlight Setting:** Allows you to set the spotlight to **Always On**.

Storing Pictures and Videos

Your phone's pictures, video, and audio recordings storage area is called the Media Center. There are two types of folders in the Media Center: Phone and Card.

Setting Storage Options

1. Press  > **Settings** > **Memory Card** > **Store Media**.
2. Select **On Phone** or **Prefer on Card**.

Phone Folder

Your phone's internal storage area is called the Phone folder. From the Phone folder, you can view all the pictures and videos you have stored there, send items (via Direct Send, Bluetooth, or messaging), delete files, and access additional options.

To review your stored pictures and videos in the phone:

1. Press  > **Multimedia** > **Media Center**.
2. Use the navigation keys to select **Phone: All** and view saved pictures and videos.

Card Folder

You can save pictures and videos directly to the microSD card. Several pictures can be stored and managed in each folder on the microSD card, depending on its capacity.

To review your pictures and videos on the microSD card:

1. Press  > **Multimedia** > **Media Center**.
2. Use the navigation keys to select **Card: All** and view saved pictures and videos.

Phone Folder and Card Folder Options

When you are highlighting a picture or video file in the phone or microSD card folders, press  to display the following options:

- **Delete** to delete the selected file.
- **Lock** to lock the selected file.
- **Rename** to rename the selected file.
- **Send Via...** to send the file via Direct Send, Bluetooth, or Messaging.
- **Camera** to activate Camera mode.
- **Remove Card** to enable the memory card removal.

- **Set As Caller ID** to display the currently highlighted picture for incoming calls from a specific Contacts entry. Select an entry and press **OK**.
- **Set As Wallpaper** to display the currently highlighted picture as a wallpaper. Select **Internal Display**, **External Display**, or **Both** and press **OK**.
- **Copy To Card/Phone** to copy the file from the current folder to the other.
- **Move To Card/Phone** to move the file from the current folder to the other.
- **Delete All** to delete all files in the folder.
- **Filter** to select the media type to view from **Phone: All**, **Phone: Pictures**, **Phone: Audio**, **Phone: Video**, **Card: All**, **Card: Pictures**, **Card: Audio**, and **Card: Video**.
- **Set View** to switch the display from **Plain List View** to **Thumbnail List View**.
- **Memory Usage** to verify memory usage.
- **Memory Card** to go to the memory card menu.
- **Edit** to display the following options (pictures only):
 - **Crop** to crop the selected picture.
 - **Rotate/Flip** to rotate or flip the selected picture.
 - **Color Adjustments** to select a color setting for the picture.
 - **Resize** to resize the picture.
 - **Borders** to add a border to the picture.
 - **Stamps** to add a stamp to the picture.
 - **Text** to add text to the picture.
 - **Text Bubble** to add a text bubble to the picture.
- **Setup** to **Sort** files (**By Time** or **By Name**), and to turn **Remember Filter** on or off.

12. Bluetooth

- ◆ Turning Bluetooth On and Off (page 132)
- ◆ Bluetooth Menu (page 133)
- ◆ Connecting Bluetooth Devices (page 133)
- ◆ Sending Items via Bluetooth (page 135)

Turning Bluetooth On and Off

Bluetooth is a short-range communications technology that allows you to connect wirelessly to a number of Bluetooth devices, such as headsets and hands-free car kits, and Bluetooth-enabled handhelds, computers, printers, and wireless phones. The Bluetooth communication range is usually up to approximately 30 feet. By default, your device's Bluetooth feature is turned off. Turning Bluetooth on makes your phone "discoverable" by other in-range Bluetooth devices.

To turn Bluetooth on:

1. Press  > **Tools** > **Bluetooth** > **Setup** > **Power**.
2. Select **On** and press  to enable Bluetooth.

To turn Bluetooth off:

1. Press  > **Tools** > **Bluetooth** > **Setup** > **Power**.
2. Select **Off** and press  to disable Bluetooth.

To turn discoverable mode on:

- ▶ Press  > **Tools** > **Bluetooth** > **Setup** > **Find Me Duration**.

For the duration selected under **Find Me Duration**, the phone will be discoverable by other devices that are within range.

Bluetooth Status Indicators

The Bluetooth status indicators on your phone's display screen shows your Bluetooth connection status at a glance:

No Status Indicator – Bluetooth is disabled (default status)

 – Status indicator will blink when the phone is in discovery mode.

❶ – Status indicator will be solid when connected to a Bluetooth device.

Bluetooth Menu

The **Bluetooth** menu allows you to set up many of the characteristics of your phone's Bluetooth service.

1. Press **[Menu]** > **Tools** > **Bluetooth**.
2. Set your Bluetooth options.
 - Select **Audio Devices** to discover and connect to hands-free devices.
 - Select **Pair to Devices** to scan for and pair your phone to an available Bluetooth device.
 - Select **Device History** to link to devices that have been connected to your phone.
 - Select **Setup** to turn Bluetooth on and off, rename your phone for Bluetooth, and set the time for the **Find Me** command listed below.
 - Select **Find Me** to make your phone discoverable to Bluetooth devices for a period of time.

- **File Transfer Help** opens a help file about transferring files via Bluetooth from your computer.

Connecting Bluetooth Devices

Pairing and Connecting

1. Press **[Menu]** > **Tools** > **Bluetooth** > **Audio Devices** > **[Look for Devices]** to connect to a hands-free device.
– or –
Press **[Menu]** > **Tools** > **Bluetooth** > **Pair to Devices** to pair with a device. (Your phone will display a list of discovered in-range Bluetooth devices.)
2. Highlight a device and press **[OK]**.
3. Follow the prompts, including entering a PIN if requested, and press **[OK]** to complete the connection.

Pairing uses a PIN to establish a trusted connection between your phone and another Bluetooth device. This PIN is stored for future connections.

Note: Due to different specifications and features of other Bluetooth-compatible devices, display and operations may be different, and functions such as transfer or exchange may not be possible with all Bluetooth-compatible devices.

Connecting to a Stored Device

If you have previously connected to a device, the device will be stored on your phone so you can connect with it easily.

1. Press **☰** > **Tools** > **Bluetooth** > **Audio Devices** and then select a device.
2. If prompted to bond with the device, press **Yes** (left softkey).
3. If prompted, enter the Bluetooth PIN and press **Ok** (left softkey). Your phone will connect to the device.

Using Bluetooth During a Call

During a call, you can connect with available Bluetooth devices.

Note: If the Hands Free menu contains only one device, then your phone will automatically try to connect to that device.

To use Bluetooth during a call:

1. While in a call, press **☰** > **Use Bluetooth**.
2. Select a device.

Disconnecting From a Device

1. Press **☰** > **Tools** > **Bluetooth** > **Audio Devices**.
2. Press **Drop** (left softkey) and then press **Yes** (left softkey).

Note: Pressing **No** (right softkey) when prompted exits the menu without disconnecting the device.

Understanding Bluetooth Access Settings

A Bluetooth device can have either **Automatic** or **Ask** security access. The first time a Bluetooth device connects to your MOTOROLA BRUTE, you must grant the device permission to connect. You can then change the access setting of the device to either **Automatic** or **Ask**.

If you set a device to **Automatic**, that device can connect automatically to your phone when it is in range. If you set a device to **Ask**, that device must

request permission before it can connect to your phone.

Devices are automatically granted permission during the ten seconds after connecting.

The default for hands-free devices, such as Bluetooth headsets, is **Automatic**.

Setting Device Details

The device history stores a list of up to 20 devices that have connected with your phone.

► Press **[Menu] > Tools > Bluetooth > Device History**.

From the device history, highlight a device and press **Edit** (left softkey) to edit the device name and change the access settings. To delete a device, highlight it, press **[Menu] > Delete**, and then press **Yes** (left softkey).

Note: If you delete a device from device history, you will have to find the device to connect with it. (See “Pairing and Connecting” on page 133.)

Sending Items via Bluetooth

Sending Contacts, Datebook Events and Media Center Items

Bluetooth lets you send Contacts entries, Datebook events, and compatible Media Center items to connected devices.

Files sent or received may be up to 10 MB.

You can only connect your phone to one device at a time.

Note: Go to www.nextel.com and click on **Accessories** for a list of MOTOROLA BRUTE Bluetooth-compatible devices.

Sending Contacts

1. Press **[Menu] > Contacts**.
2. Highlight a contact and press **[Menu] > Send Via... > Bluetooth**.
3. Select a device or search for a device by selecting **[Look for Devices]**.

4. If prompted, bond with the device. Your phone connects to the device and transfers the contact.

Sending Datebook Events

1. Press **[Menu]** > **Tools** > **Datebook**.
2. Highlight an event and press **[Menu]** > **Send Via....**
 - For a repeating event, select **This Event Only** to send only this occurrence or **Repeat Event** to send all instances.
3. Select **Bluetooth**.
4. Select a device or search for a device by selecting **[Look for Devices]**.
5. If prompted, bond with the device. Your phone connects to the device and transfers the event.

Sending Media Center Items

You can only send audio files and pictures if they are not forward locked and if their DRM settings do not prevent you from sending them.

1. Press **[Menu]** > **Multimedia** > **Media Center**.
2. Highlight a file and press **[Menu]** > **Send Via... > Bluetooth**.

3. Select a device or search for a device by selecting **[Look for Devices]**.
4. If prompted, bond with the device. Your phone connects to the device and transfers the file.

Receiving Items

You receive a prompt when your phone has an incoming transfer.

- ▶ Press **Accept** (left softkey) to accept the transfer or press **Reject** (right softkey) to reject the transfer.

Note: Media files transferred from a PC may be copied to your microSD card's root directory and may not be accessible by your phone. To check the location, connect your phone to your computer as a USB mass storage device and move the files to the appropriate folders.

Canceling Transfers

You can cancel a transfer while in progress.

1. Press **Cancel** (right softkey).
2. Press **Yes** (left softkey) to cancel, or press **No** (right softkey) to continue with the transfer.

Viewing and Storing Received Items

After an incoming transfer is complete, your phone translates the item and it appears on the display.

You can choose to either store or discard the item. Items are stored as follows:

- Contact entries are stored to Contacts.
- Pictures and audio files are stored to their folders and are accessible through the Media Center.
- Datebook events are stored to Datebook.
 - ▶ To store an item, press **Store** (left softkey).
 - ▶ To discard an item without saving it, press **Discard** (right softkey).

13. Multimedia

- ◆ Media Center (page 138)
- ◆ My Music (page 142)
- ◆ My Images (page 150)
- ◆ My Videos (page 151)

Media Center

The Media Center provides convenient access to all supported multimedia files on your device or your memory card.

Note: The Media Center cannot read the Music and Podcast folder from the microSD card.

All pictures stored in your phone's memory can be accessed through the Media Center.

The following audio recordings can be accessed through the Media Center:

- Voice records created when your phone was not in a call.
- Musical ringtones in the list of ringtones.
- Audio files saved from MMS messages.
- Audio files (songs, recordings, podcasts) you downloaded to your phone.

Pictures and audio files accessible through the Media Center can be sent in MMS messages, subject to message size limitations. See “Creating and Sending Messages” on page 50 for information on MMS.



Viewing the Media Center

1. Press  > **Multimedia** > **Media Center**.
2. Scroll to view the items in the Media Center.

Choosing Thumbnail View or List View

1. Press  > **Multimedia** > **Media Center** >  > **Set View**.
2. Select **Thumbnail List View** or **Plain List View**.

Filtering by Media Type

- ▶ Press  > **Multimedia** > **Media Center** >  > **Filter** and select a filtering option: **Phone: All, Phone: Pictures, Phone: Audio, Phone: Video, Card: All, Card: Pictures, Card: Audio, or Card: Video**



Keeping the Last Filter Setting

You can set the Media Center to show all items every time you access it or to keep the filtering setting you had when you last viewed it.

- ▶ Press  > **Multimedia** > **Media Center** >  > **Setup** > **Remember Filter** > **On**.

When you receive your phone, the Media Center is set to show all items every time you access it.

Accessing Items

1. Press  > **Multimedia** > **Media Center**.
2. Highlight an item and press  to select it.
3. Scroll right or left to access additional items.

Sorting by Time or Name

1. Press  > **Multimedia** > **Media Center** >  > **Setup** > **Sort**.
2. Select **By Time** to sort by the time items were created or **By Name** to sort alphabetically.

When you receive your phone, the Media Center is set to sort items by time.

Forward Locked Items

Some items saved to the Media Center may be forward locked. Forward locked items are usually copyright protected, and they cannot be sent or shared.

You cannot remove forward locking from an item.

When you view items in the Media Center, one of these icons appears next to each forward locked item:



Forward locked.



Forward lock and locked.

When an item is locked, it cannot be deleted from the Media Center. See “Locking Items” on page 140. Locking an item has no effect on its forward locking.

DRM Items

Except for Java applications, which download to Java Apps, the default location for any DRM items that you download is the Media Center.



Depending on how a vendor has set rights for an item, the item may include the following status icons.

 The item is a DRM item.

 The DRM item has expired.

All DRM items are forward locked. As with other items in the Media Center, you can lock DRM items. See “Locking Items” on page 140.



Renaming Items

1. Press  > **Multimedia** > **Media Center**.
2. Highlight or select an item and then press  > **Rename**.

3. Delete the current name, enter a new name, and press .

Locking Items



When you lock an item in the Media Center, it cannot be deleted until you unlock it.

1. Press  > **Multimedia** > **Media Center**.
2. Highlight or select an item and then press  > **Lock** or **Unlock** to lock or unlock the item.

Deleting Items

Deleting items from the Media Center means they can no longer be accessed anywhere in your phone, including the list of ringtones, the list of voice records, and Contacts.

Deleting an Item

1. Press  > **Multimedia** > **Media Center**.
2. Highlight or select an item and then press  > **Delete**.
3. Press **Yes** (left softkey) to confirm.

Deleting All Items

You can delete all unlocked items currently in view, depending on how Media Center filtering is set. See “Filtering by Media Type” on page 139. If filtering is set to show all types of Media Center items, all unlocked items are deleted.

1. Press **[Menu]** > **Multimedia** > **Media Center**.
2. Press **[Menu]** and then select **Delete All**.
3. Press **Yes** (left softkey) to confirm.

Tip: If you delete items you have purchased and downloaded, including DRM items, you will usually have to repurchase the item if you decide you want it back. Certain DRM vendors may not charge you to download an item multiple times within a given time frame. Please contact the vendor for details.

Viewing Memory Usage

1. Press **[Menu]** > **Multimedia** > **Media Center**.
2. Highlight or select any item in the Media Center.
3. Press **[Menu]** > **Memory Usage**.

To free memory, delete items.

Pictures

The Media Center lets you view pictures and send them in MMS messages, with Nextel Direct Send, or with Bluetooth. You can also assign them to Contacts entries or set them as your phone’s wallpaper.

Viewing Pictures

- ▶ To view a picture, highlight it from the list of items in the Media Center and press **[OK]**.

If your phone is set to show thumbnails, a thumbnail of each picture appears next to the picture in the list of items. If your phone is not set to show thumbnails, this icon  appears next to the picture.

To see a larger or smaller view of the picture you are viewing:

- ▶ Press **[Menu]** > **Zoom** and select a setting.

If the picture does not fit in the display, use the navigation key to view different parts of the picture.

Sending Pictures in a Message

1. Highlight or select a picture and then press **Send** (left softkey) or press **[Menu]** > **Send Via...** > **Messaging**.

2. Create and send the message. (See “Creating and Sending Messages” on page 50.) The picture you selected is automatically attached.

Sending Pictures With Direct Send

1. Highlight or select a picture and press  > **Send Via... > Direct Send.**
2. Select **A Contact** or **A Recent Call** and select an available recipient.
3. Press the DC button to send the picture.

Sending Pictures With Bluetooth

You must set up your phone to send items using Bluetooth before you can send a picture. See “12. Bluetooth” on page 132.

1. Highlight or select a picture and press  > **Send Via... > Bluetooth.**
2. Select a device or search for a device by selecting **[Look for Devices]**.
3. If prompted, bond with the device. Your phone connects to the device and transfers the picture.

Setting Pictures as Wallpaper

- ▶ Highlight or select a picture and press  > **Set As Wallpaper.**

My Music

My Music groups your audio files into folders and lists. When you select an audio file to play, My Music plays the file and then plays the other audio files grouped with it.

In addition to music, My Music plays podcasts that you have downloaded to your computer and then saved on your memory card.

If you receive calls or notifications while playing an audio file with My Music, the audio file pauses and a prompt asks you to accept or ignore the incoming call or alert.

Accessing My Music

1. Press  > **Multimedia > My Music** to launch the My Music player.

2. Press the navigation key up or down to select your music.
3. Press **OK** to play music.

Exiting My Music

- ▶ To exit My Music, press **Exit** (right softkey). (If **Exit** is not an option, press **Back** [right softkey] until it is.)

How Audio Files Are Organized

My Music groups audio files on the memory card into folders and lists. Unless the phone determines a file is a podcast, it treats all audio files as songs.

When you access My Music, you see that the audio files are grouped into these folders:

- **Songs** — All audio files on the memory card (except podcasts), listed alphabetically by title.
- **Playlists** — Folders and lists you have created. The default playlist is Favorites.
- **Albums** — Songs grouped by album title.
- **Artists** — Songs grouped by alphabetically by artist and title.
- **Genres** — Songs grouped by genre.

- **Podcasts** — Podcast episodes grouped alphabetically by program. Episodes are sorted by date.
- **Other** — Other songs group alphabetically.

If there is not enough album, artist, or genre data associated with a file, it is grouped as “Unknown”.

Naming Audio Files

File names can include up to 255 characters, including the file format extension (for example, mp3). Only the first 32 characters will be displayed. If a file name is longer than 255 characters, it will not be visible on the player and cannot be played. In this case, you will need to rename the file and resave it to the memory card.

Playing Audio Files

Note: Audio File Formats: My Music does not support all audio file formats or bit rates/sampling rates. Supported extensions include .3ga, .3gp, .aac, .amr, .au, .awb, .imy, .m4a, .mid, .midi, .mmf, .mp3, .mp4, .mpga, .mxmf, .ra, .ram, .rm, .smf, .wav, .wma, .xmf, .xmf0, and .xmf1.

1. Press **MM** > **Multimedia** > **My Music**.
2. Highlight a folder.

Tip: The Songs folder contains all the audio files, except podcasts, on the memory card in a single list.

To quickly navigate through lists, enter the first letter of a file or folder to skip to the entries beginning with that letter.

3. To play the first audio file in the folder, press **Play** (left softkey). (If the folder you scrolled to contains subfolders, this plays the first audio file in the first of these subfolders.)

– or –

Press **OK** to view the contents of the folder. Then highlight a file and press **Play** (left softkey) or press **OK** to play it.

Any time you are viewing a list of folders with My Music, you can highlight a folder and press **Play** (left softkey) to start playing the contents of that folder or press **OK** to view the contents of the folder.

Any time you are viewing a list of audio files, you can highlight a file and press **Play** (left softkey) to play it.

Press **Back** (right softkey) to return to the previous view.

Pause and Resume

- ▶ To pause a playing audio file, press **Pause** (left softkey).
- ▶ To resume playing a paused audio file, press **Play** (left softkey).

Skip to Next and Skip to Previous

- ▶ To skip to the next audio file, press the navigation key to the right.
- ▶ To skip to the previous audio file, press the navigation key to the left.

Fast-Forward and Rewind

- ▶ To fast-forward a playing audio file, press and hold the navigation key to the right.
- ▶ To rewind a playing audio file, press and hold the navigation key to the left.

Adjusting the Volume

- ▶ To adjust the volume, use the volume button.

Playing Music in the Background

Your phone can continue to play music in the background while you are accessing other features.

To play music in the background:

- ▶ With music playing, press  > **Hide Player**.

The music player continues playing and the display returns to standby mode. To return to the music player, press **Music** (right softkey).

Playing a List and Using Repeat and Shuffle

You can play audio files in a selected list in order (default), you can select the **Repeat** option to have a list or song repeat automatically, or you can select the **Shuffle** option to have the files play continuously in random order.

To set repeat:

1. While viewing a list, viewing audio file details, or viewing visuals, press  > **Setup**.
2. Highlight **Repeat** and then press the navigation key right or left to select an option:
 - **All** to repeat the list from the beginning.

- **One** to repeat the current song.

- **Off** to turn repeat off.

3. Press **Back** (right softkey) to return to the previous screen.

To set shuffle:

1. While viewing a list, viewing audio file details, or viewing visuals, press  > **Setup**.
2. Highlight **Shuffle** and then press the navigation key right or left to select **On** or **Off**.
3. Press **Back** (right softkey) to return to the previous screen.

DRM Items

Some of the audio files on the memory card may be DRM (digital rights management) items. When a DRM item has expired, you can no longer play it.

If you highlight an audio file that is expired and try to play it, a message saying you cannot play it appears. If you play a list containing an expired audio file, My Music skips over the expired item and no message is displayed.

Working With Playlists

Playlists let you group audio files that you'd like to hear together. Adding or removing songs from playlists, or deleting entire playlists, does not copy, move, or delete files from your memory card.

Creating a Playlist

1. Press **[Menu]** > **Multimedia** > **My Music** > **Playlists** > **[Create New]** > **Name**.
2. Enter a name and press **[OK]**.

Note: If you do not assign a name, the playlist is named "Playlist" followed by the number of unnamed playlists you have. For example, the first unnamed playlist you create will be named "Playlist-1".

3. Select **[Add Songs]**. (You will see a list of available audio files.)
4. Select each audio file for the playlist. A checkmark appears next to each selected file.
5. When you are finished selecting files, press **Done** (left softkey).
6. Press **Save** (left softkey).

Editing a Playlist

After you have created a playlist, you can change its name, add audio files, remove audio files, and change the order of the audio files.

1. Press **[Menu]** > **Multimedia** > **My Music** > **Playlists**.
2. Highlight a playlist and press **[Menu]** > **Edit Playlist**.
3. Make your changes and press **Save** (left softkey).

Reordering a Playlist



You can change the order of the audio files on a playlist.

1. Before you have saved a new playlist or while editing a playlist, press **[Menu]** > **Reorder Songs**.
2. Highlight a title and press **Grab** (left softkey).
3. Highlight a new location and press **Insert** (left softkey).
4. Repeat steps 2 and 3 for all the items you are moving.
5. Press **Done** (right softkey) and then press **Save** (left softkey).



Removing Files From Playlists

You can remove some or all audio files from a playlist.

To remove a file from a playlist:

1. Before you have saved a new playlist or while editing a playlist, press .
2. Highlight an audio file and press  > **Remove Song**.
3. Press **Save** (left softkey).

To remove all files from a playlist:

1. Before you have saved a new playlist or while editing a playlist, press  > **Remove All Songs**.
2. Press  or **Yes** (left softkey) to confirm.
3. Add new songs to the playlist and then press **Save** (left softkey).

Note: Empty playlists cannot be saved.

Deleting Playlists

To delete a playlist:

1. Press  > **Multimedia** > **My Music** > **Playlists**.

2. Highlight a playlist and press  > **Delete Playlist**.

3. Press **Yes** (left softkey) to confirm.

To delete all playlists:

1. Press  > **Multimedia** > **My Music** > **Playlists**.
2. Press  > **Delete All Playlists**.
3. Press **Yes** (left softkey) to confirm.

This deletes all playlists except Favorites.

Using the Favorites Playlist

The Favorites playlist is a permanent playlist. You can add, remove, and change the order of the files, but you cannot rename it or delete it.

You can add audio files to the Favorites playlist as you would any other playlist.

You can also add audio files to the Favorites playlist using the Add to Favorites shortcut.

To add the current audio file to Favorites:



- ▶ While viewing a list, viewing the details of the audio file currently playing, or viewing visuals, press  > **Add to Favorites**.

To add any audio file to Favorites:

1. Press  > **Multimedia** > **My Music** > **Songs**.
2. Highlight a file and press  > **Add to Favorites**.

Podcasts



To access and play podcasts:

1. Press  > **Multimedia** > **My Music** > **Podcasts**.
2. Scroll to view individual podcast episodes or folders containing multiple episodes of the same program.
3. Press  to view the podcast episodes within a folder or the details screen of an individual podcast episode.
4. To play a selected podcast, press **Play** (left softkey).



Deleting Audio Files

You can delete audio files from the memory card one at a time, by album, by artist, or by genre, or by deleting everything in the Songs, Albums, Artists, or Genres folders.

Deleting an Audio File

1. Press  > **Multimedia** > **My Music**.
2. Select the folder containing the audio file.
3. Highlight the audio file and press  > **Delete Song** or **Delete Podcast**.
4. Press **Yes** (left softkey) to confirm.

Deleting an Album, Artist, or Genre

1. Press  > **Multimedia** > **My Music**.
2. Select the folder containing the audio files: **Albums**, **Artists**, or **Genres**.
3. Highlight an album, artist, or genre, and press  > **Delete Album**, **Delete Artist**, or **Delete Genre**.
4. Press **Yes** (left softkey) to confirm.

Deleting All Audio Files

Deleting everything in the Songs, Albums, Artists, or Genres folder deletes all audio files from the memory card.

1. Press **[Menu]** > **Multimedia** > **My Music** > **Songs, Albums, Artists, or Genres**.
2. Press **[Menu]** > **Delete Songs** > **[Menu]** > **All**.
3. Press **[OK]** or **Yes** (left softkey) to confirm.

Deleting All Podcasts

1. Press **[Menu]** > **Multimedia** > **My Music** > **Podcasts** > **[Menu]** > **Delete Podcasts**.
2. Press **[OK]** or **Yes** (left softkey) to confirm.

Setting Audio and Visual Options

You can customize the sound of My Music by setting the equalizer. You can customize the look of My Music screen by choosing a theme or by viewing visuals while listening to an audio file.

Setting the Equalizer

1. From anywhere in My Music, press **[Menu]** > **Setup** > **Equalizer**.
2. Select a mode and press **Back** (right softkey).

Viewing Visuals

To view visuals instead of song details:

1. While viewing the details of the audio file currently playing, press **[Menu]** > **Setup** > **Visuals**, and use the navigation key to select an option.
2. Press **Back** (right softkey).



To view song details instead of visuals:

1. While viewing visuals press **[Menu]** > **Setup** > **Visuals** > **Off**.
2. Press **Back** (right softkey).

My Images

The My Images application lets you easily browse, edit and view a slideshow of images on your phone or memory card on your internal display, or browse, view a slideshow on the external display.



My Images Menu

The My Images menu has many image management features. The following options are available for existing images by pressing  > **Multimedia** > **My Images** > .

- **Edit** displays several options for editing your photos including: Crop, Rotate/Flip, Color Adjustment, Resize, Borders, Stamps, Text, and Text Bubble.
- **SlideShow** starts a slideshow containing images from the currently highlighted image.
- **Save as New** lets you save an image with a new name.
- **Preview** displays the highlighted image.
- **Rename** lets you rename the image.
- **Delete Current** deletes the highlighted image.

- **Delete Multiple** lets you choose multiple images to delete at one time.
- **Switch to Phone/Card** toggles between images stored on the phone or memory card.
- **Set as wallpaper** sets the highlighted image as the phone's wallpaper.
- **Set As Caller ID** sets the highlighted image as the caller ID for a contact.
- **Send Via Bluetooth** lets you send image via Bluetooth.

Viewing Images

1. Press  > **Multimedia** > **My Images** or press  > **Games and Apps** > **My Images**.
2. Press  > **SlideShow** to view a show of all images in the current folder.
3. Press the navigation key left or right to scroll through the images.

Editing Images

My Images has several options for editing your photos including: **Crop, Rotate/Flip, Color Adjustments, Resize, Borders, Stamps, Text**, and **Text Bubble**.

- ▶ Press  > **Multimedia** > **My Images** >  > **Edit** and follow the prompts to edit the picture.



My Videos

The My Videos application lets you easily browse and view video files on your phone or memory card.

- ▶ Press  > **Multimedia** > **My Videos** or press  > **Games and Apps** > **My Videos**.

Note: Video File Formats: My Videos does not support all video file formats or resolutions and bit/frame rates. Supported extensions include .3gp, .asf, .mp4, .rm, .rmvb, .mpg, and .wmv.

Viewing Videos

- ▶ From the My Videos display, highlight a video and press  to begin playback.
 - My Videos will display the video in portrait mode by default.
 - To change the default to landscape mode press  > **Full Screen**.
 - When viewing a video, use the  button to pause or play the video playback.
 - Press and hold the navigation key to the right to fast forward the video.
 - Press and hold the navigation key to the left to rewind the video.

My Videos Setup Menu

- ▶ Press  > **Multimedia** > **My Videos** >  > **Setup**.

The My Videos Setup Menu allows you to change settings for **View**, **3D Audio** and **Reverbs**.

*Safety and Warranty
Information*

S1. Important Safety Information

- ◆ General Precautions (page 154)
- ◆ Maintaining Safe Use of and Access to Your Phone (page 155)
- ◆ Battery Use and Safety (page 158)
- ◆ Using Your Phone With a Hearing Aid Device (page 161)
- ◆ Caring for the Environment by Recycling (page 163)
- ◆ Export Law Assurances (page 163)
- ◆ California Perchlorate Label (page 163)
- ◆ Radio Frequency (RF) Energy (page 164)
- ◆ Owner's Record (page 168)
- ◆ Patent and Trademark Information (page 168)
- ◆ Software Copyright Notice (page 169)
- ◆ Privacy and Data Security (page 170)
- ◆ Smart Practices While Driving (page 170)

Failure to read and follow the information provided in this phone guide may result in serious bodily injury, death, or property damage.

General Precautions

There are several simple guidelines to operating your phone properly and maintaining safe, satisfactory service.

- To maximize performance, do not touch the bottom portion of your phone where the internal antenna is located while using the phone.
- Speak directly into the mouthpiece.
- Avoid exposing your phone and accessories to rain or liquid spills. If your phone does get wet, immediately turn the power off and remove the battery.
- Do not expose your phone to direct sunlight for extended periods of time (such as on the dashboard of a car).
- Although your phone is quite sturdy, it is a complex piece of equipment and can be broken. Avoid dropping, hitting, bending, or sitting on it.
- Any changes or modifications to your phone not expressly approved in this document could void your warranty for this equipment and void your authority to operate this equipment.

Note: For the best care of your phone, only authorized personnel should service your phone and accessories. Failure to do so may be dangerous and void your warranty.

Tip: Purchase an optional hands-free accessory at your local Sprint Store, or call Nextel at 1-866-866-7509.

Maintaining Safe Use of and Access to Your Phone

Do Not Rely on Your Phone for Emergency Calls

Mobile phones operate using radio signals, which cannot guarantee connection in all conditions. Therefore you should never rely solely upon any mobile phone for essential communication (e.g., medical emergencies). Emergency calls may not be possible on all cellular networks or when certain network services or mobile phone features are in use. Check with your local service provider for details.

Using Your Phone While Driving

Talking on your phone while driving (or operating the phone without a hands-free device) is prohibited in some jurisdictions. Laws vary as to specific restrictions. Remember that safety always comes first.

Responsible driving practices can be found in “Smart Practices While Driving” on page 170 and/or at the Motorola website: www.motorola.com/callsmart.

Following Safety Guidelines

To operate your phone safely and efficiently, always follow any special regulations in a given area. Turn your phone off in areas where use is forbidden or when it may cause interference or danger.

Using Your Phone Near Other Electronic Devices

Most modern electronic equipment is shielded from radio frequency (RF) signals. However, RF signals from wireless phones may affect inadequately shielded electronic equipment.

RF signals may affect improperly installed or inadequately shielded electronic operating systems or entertainment systems in motor vehicles. Check with the manufacturer or their representative to determine if these systems are adequately shielded from external RF signals. Also check with the manufacturer regarding any equipment that has been added to your vehicle.

Consult the manufacturer of any personal medical devices, such as pacemakers and hearing aids, to determine if they are adequately shielded from external RF signals.

Operational Precautions

Note: Always turn off the phone in healthcare facilities, and request permission before using the phone near medical equipment.

To assure optimal radio product performance and to be sure that human exposure to RF does not exceed the guidelines set forth in the relevant standards, always follow these instructions and precautions:

Phone Operation

When placing or receiving a phone call, hold your radio product as you would a wireline telephone. Speak directly into the microphone.

Two-way Radio Operation

Your radio product has been designed and tested to comply with national and international standards and guidelines regarding human exposure to RF electromagnetic energy, when operated in the two-way mode (at the face, or at the abdomen when using an audio accessory) at usage factors of up to 50% talk/50% listen.

Transmit no more than the rated duty factor of 50% of the time. To transmit (talk), push the PTT button. To receive calls, release the PTT button. Transmitting 50% of the time or less, is important because this radio generates measurable RF energy only when transmitting (in terms of measuring for standards compliance).

When using your radio product as a traditional two-way radio, hold the radio product in a vertical position with the microphone one to two inches (2.5 to 5 cm) away from the lips.



If you wear a radio product on your body when transmitting, always place the radio product in a Motorola approved clip, holder, holster, case or body harness. If you do not use a body-worn accessory supplied or approved by Motorola and are not using the radio product in the intended use positions along side the head in the phone mode or in front of the face in the two-way radio mode, or if you hang your device from a lanyard around your neck, keep the device at least 2.5 centimeters (1 inch) from your body when transmitting.

Approved Accessories

For a list of approved Motorola accessories call **1-800-453-0920**, or visit our website at www.motorola.com/phoneaccessories.

Turning Off Your Phone Before Flying

Turn off your phone before boarding any aircraft. To prevent possible interference with aircraft systems, the U.S. Federal Aviation Administration (FAA) regulations require you to have permission from a crew member to use your phone while the plane is on the ground. To prevent any risk of interference, FCC regulations prohibit using your phone while the plane is in the air.

Turning Off Your Phone in Dangerous Areas

To avoid interfering with blasting operations, turn your phone off when in a blasting area or in other areas with signs indicating two-way radios should be turned off. Construction crews often use remote-control RF devices to set off explosives.

Turn your phone off when you're in any area that has a potentially explosive atmosphere. Although it's rare, your phone and accessories could generate sparks. Sparks can cause an explosion or fire, resulting in bodily injury or even death. These areas are often, but not always, clearly marked. They include:

- Fueling areas such as gas stations.
- Below deck on boats.
- Fuel or chemical transfer or storage facilities.
- Areas where the air contains chemicals or particles such as grain, dust, or metal powders.
- Any other area where you would normally be advised to turn off your vehicle's engine.

Note: Never transport or store flammable gas, flammable liquids, or explosives in the compartment of your vehicle that contains your phone or accessories.

Keep Your Mobile Device and Its Accessories Away From Small Children

These products are not toys and may be hazardous to children. For example:

- A choking hazard may exist for small, detachable parts.
- Improper use could result in loud sounds, possibly causing hearing injury.
- Improperly handled batteries could overheat and cause a burn.

Do not allow children to play with your phone as they could hurt themselves and others, damage the phone or make calls that increase your invoice.

Glass Parts

Some parts of your phone may be made of glass. This glass could break if the product is dropped on a hard surface or receives a substantial impact. If glass breaks, do not touch or attempt to remove. Stop using your phone until the glass is replaced by a qualified service center.

Seizures/Blackouts

Some people may be susceptible to epileptic seizures or blackouts when exposed to flashing lights, such as when playing video games. These may occur even if a person has never had a previous seizure or blackout.

If you have experienced seizures or blackouts, or if you have a family history of such occurrences, please consult with your physician before playing video games or enabling a flashing-lights feature (if available) on your phone.

Discontinue use and consult a physician if any of the following symptoms occur: convulsion, eye or muscle twitching, loss of

awareness, involuntary movements, or disorientation. It is always a good idea to hold the screen away from your eyes, leave the lights on in the room, take a 15-minute break every hour, and stop use if you are very tired.



Caution About High Volume Usage

WARNING: Exposure to loud noise from any source for extended periods of time may affect your hearing. The louder the volume sound level, the less time is required before your hearing could be affected.

To protect your hearing:

- Limit the amount of time you use headsets or headphones at high volume.
- Avoid turning up the volume to block out noisy surroundings.
- Turn the volume down if you can't hear people speaking near you.

If you experience hearing discomfort, including the sensation of pressure or fullness in your ears, ringing in your ears, or muffled speech, you should stop listening to the device through your headset or headphones and have your hearing checked.

For more information about hearing, see our website at direct.motorola.com/hellomoto/nss/AcousticSafety.asp (in English only).

Repetitive Motion

When you repetitively perform actions such as pressing keys or entering finger-written characters, you may experience occasional discomfort in your hands, arms, shoulders, neck, or other parts of your body. If you continue to have discomfort during or after such use, stop use and see a physician.

Battery Use and Safety

Important: **HANDLE AND STORE BATTERIES PROPERLY TO AVOID INJURY OR DAMAGE.** Most battery issues arise from improper handling of batteries, and particularly from the continued use of damaged batteries.

DON'Ts

- **Don't disassemble, crush, puncture, shred, or otherwise attempt to change the form of your battery.**
- **Don't let the phone or battery come in contact with water.** Water can get into the phone's circuits, leading to corrosion. If the phone and/or battery get wet, have them checked by your carrier or contact Motorola, even if they appear to be working properly.
- **Don't allow the battery to touch metal objects.** If metal objects, such as jewelry, stay in prolonged contact with the battery contact points, the battery could become very hot.

- **Don't place your battery near a heat source.** Excessive heat can damage the phone or the battery. High temperatures can cause the battery to swell, leak, or malfunction. Therefore:
 - Do **not** dry a wet or damp battery with an appliance or heat source, such as a hair dryer or microwave oven.
 - Avoid leaving your phone in your car in high temperatures.

DOs

- **Do avoid dropping the battery or phone.** Dropping these items, especially on a hard surface, can potentially cause damage.
- **Do contact your service provider or Motorola if your phone or battery has been damaged from dropping or high temperatures.**

Important: **USE MOTOROLA ORIGINAL PRODUCTS FOR QUALITY ASSURANCE AND SAFEGUARDS.** To aid consumers in identifying authentic Motorola batteries from non-original or counterfeit batteries (that may not have adequate safety protection), Motorola provides holograms on its batteries. Consumers should confirm that any battery they purchase has a "Motorola Original" hologram.

Motorola recommends you always use Motorola-branded batteries and chargers. Motorola mobile devices are designed to work with Motorola batteries. If you see a message on your

display such as **Invalid Battery** or **Unable to Charge**, take the following steps:

- Remove the battery and inspect it to confirm that it has a "Motorola Original" hologram;
- If there is no hologram, the battery is not a Motorola battery;
- If there is a hologram, replace the battery and retry charging it;
- If the message remains, contact a Motorola Authorized Service Center.

Important: Motorola's warranty does not cover damage to the phone caused by non-Motorola batteries and/or chargers.

WARNING: Use of a non-Motorola battery or charger may present a risk of fire, explosion, leakage, or other hazard.

Proper and Safe Battery Disposal and Recycling

Proper battery disposal is not only important for safety, it benefits the environment. Consumers may recycle their used batteries in many retail or service provider locations. Additional information on proper disposal and recycling may be found on the Web:

- www.motorola.com/recycling
- www.rbr.org/call2recycle/ (in English only)

Disposal of Lithium Ion (Lilon) Batteries: Promptly dispose of used batteries in accordance with local regulations. Contact your local recycling center or national recycling organizations for more information on how to dispose of batteries.



Do not handle a damaged or leaking Li-Ion battery as you can be burned.

WARNING: Never dispose of batteries in a fire because they may explode.

Special Note: Be sure to dispose of your battery properly. In some areas, the disposal of batteries in household or business trash may be prohibited.

Protecting Your Battery

The guidelines listed below help you get the most out of your battery's performance.

- In very limited circumstances, such as where your phone has been exposed to extreme heat Cool Down message screens will appear. To avoid possible damage to your battery and phone, you should follow these instructions until the phone is within its recommended temperature range. When your phone is in Cool Down mode, only emergency calls may be made.
- Recently there have been some public reports of wireless phone batteries overheating, catching fire, or exploding. It appears that many, if not all, of these reports involve

counterfeit or inexpensive, aftermarket-brand batteries with unknown or questionable manufacturing standards. Nextel is not aware of similar problems with Nextel phones resulting from the proper use of batteries and accessories approved by Nextel or the manufacturer of your phone. Use only Nextel-approved or manufacturer-approved batteries and accessories found at Sprint Stores or through your phone's manufacturer, or call 1-866-866-7509 to order. They're also available at www.nextel.com — click **Accessories**. Buying the right batteries and accessories is the best way to ensure they're genuine and safe.

- In order to avoid damage, charge the battery only in temperatures that range from 32° F to 113° F (0° C to 45° C).
- Don't use the battery charger in direct sunlight or in high humidity areas, such as the bathroom.
- Never dispose of the battery by incineration.
- Keep the metal contacts on top of the battery clean.
- Don't attempt to disassemble or short-circuit the battery.
- The battery may need recharging if it has not been used for a long period of time.
- It's best to replace the battery when it no longer provides acceptable performance. It can be recharged hundreds of times before it needs replacing.

- Don't store the battery in high temperature areas for long periods of time. It's best to follow these storage rules:

Less than one month:





-4° F to 140° F (-20° C to 60° C)



More than one month:

-4° F to 113° F (-20° C to 45° C)

Batteries and Chargers

Your battery, charger, or portable radio may contain symbols, defined as follows:

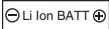
Symbol	Definition
	Important safety information follows.
	Do not dispose of your battery or phone in a fire.
	Your battery or phone may require recycling in accordance with local laws. Contact your local regulatory authorities for more information.
	Do not throw your battery or phone in the trash.

Symbol	Definition
	Your phone contains an internal lithium ion battery.
	Do not let your battery, charger, or phone get wet.
	Listening at full volume to music or voice through a headset may damage your hearing.

Using Your Phone With a Hearing Aid Device

A number of Nextel phones have been tested for hearing aid device compatibility. When some wireless phones are used with certain hearing devices (including hearing aids and cochlear implants), users may detect a noise which can interfere with the effectiveness of the hearing device.

Some hearing devices are more immune than others to this interference noise, and phones also vary in the amount of interference noise they may generate. ANSI standard C63.19 was developed to provide a standardized means of measuring both wireless phone and hearing devices to determine usability rating categories for both.

Ratings have been developed for mobile phones to assist hearing device users find phones that may be compatible with their hearing device. Not all phones have been rated for compatibility with hearing devices. Phones that have been rated have a label with the rating(s) located on the box, and are listed at www.motorola.com/accessibility.

These ratings are not guarantees. Results will vary depending on the user's hearing device and individual type and degree of hearing loss. If a hearing device is particularly vulnerable to interference noise; even a phone with a higher rating may still cause unacceptable noise levels in the hearing device. Trying out the phone with your hearing device is the best way to evaluate it for your personal needs.

M-Ratings: Phones rated M3 or M4 meet FCC requirements for hearing aid compatibility and are likely to generate less interference to hearing devices than unrated phones. (M4 is the better/higher of the two ratings.)

T-Ratings: Phones rated T3 or T4 meet FCC requirements and are likely to be more usable with a hearing device's telecoil ("T Switch" or "Telephone Switch") than unrated phones. (T4 is the better/higher of the two ratings. Note that not all hearing devices have telecoils in them.)

Hearing aid devices may also be measured for immunity to interference noise from wireless phones and should have ratings similar to phones. Ask your hearing health care professional for the rating of your hearing aid. Add the rating of

your hearing aid and your phone to determine probable usability:

- Any combined rating equal to or greater than six offers excellent use.
- Any combined rating equal to five is considered normal use.
- Any combined rating equal to four is considered usable.



Thus, if you pair an M3 hearing aid with an M3 phone, you will have a combined rating of six for "excellent use." This is synonymous for T ratings.

Nextel further suggests you experiment with multiple phones (even those not labeled M3/T3 or M4/T4) while in the store to find the one that works best with your hearing aid device. Should you experience interference or find the quality of service unsatisfactory after purchasing your phone, promptly return it to the store within 30 days of purchase. With the Sprint 30-day Risk-Free Guarantee, you may return the phone within 30 days of purchase for a full refund. More information about hearing aid compatibility may be found at: www.motorola.com/accessibility, www.fcc.gov, www.fda.gov, and www.accesswireless.org.

Getting the Best Hearing Device Experience With Your Phone

To further minimize interference:

- Set the phone's display and keypad backlight settings to ensure the minimum time interval:

1. Press  > **Settings** > **Display/Info** > **Backlight** > **Timer** or **Java Timer**.
 2. Highlight the minimum time interval setting and press .
- Position the phone so the internal antenna is farthest from your hearing aid.
 - Move the phone around to find the point with least interference.

Caring for the Environment by Recycling



This symbol on a Motorola product means the product should not be disposed of with household waste.

Disposal of your Mobile Device and Accessories

Please do not dispose of mobile devices or electrical accessories (such as chargers, headsets, or batteries) with your household waste. These items should be disposed of in accordance with the national collection and recycling schemes operated by your local or regional authority. Alternatively, you may return unwanted mobile devices and electrical accessories to any Motorola Approved Service Center in your region. Details of Motorola approved national recycling

schemes, and further information on Motorola recycling activities can be found at: www.motorola.com/recycling.

Disposal of your Mobile Device Packaging and User's Guide

Product packaging and user's guides should only be disposed of in accordance with national collection and recycling requirements. Please contact your regional authorities for more details.

Export Law Assurances

This product is controlled under the export regulations of the United States of America and Canada. The Governments of the United States of America and Canada may restrict the exportation or re-exportation of this product to certain destinations. For further information contact the U.S. Department of Commerce or the Canadian Department of Foreign Affairs and International Trade.

California Perchlorate Label

Some mobile phones use an internal, permanent backup battery on the printed circuit board that may contain very small amounts of perchlorate. In such cases, California law requires the following label:

Perchlorate Material – special handling may apply. See www.dtsc.ca.gov/hazardouswaste/perchlorate. There is no special handling required by consumers.

Radio Frequency (RF) Energy

This section contains important information on the safe and efficient operation of your mobile device. Read this information before using your mobile device.

Exposure to Radio Frequency (RF) Energy

Your mobile device contains a transmitter and receiver. When it is ON, it receives and transmits RF energy. When you communicate with your mobile device, the system handling your call controls the power level at which your mobile device transmits.

Your Motorola mobile device is designed to comply with local regulatory requirements in your country concerning exposure of human beings to RF energy.

Operational Precautions

For optimal mobile device performance, and to be sure that human exposure to RF energy does not exceed the guidelines set forth in the relevant standards, always follow these instructions and precautions.

Product Operation

When placing or receiving a phone call, hold your mobile device just like you would a landline phone.

If you wear the mobile device on your body, always place the mobile device in a Motorola-supplied or approved clip, holder, holster, case, or body harness. If you do not use a body-worn accessory supplied or approved by Motorola—or if you hang your mobile device from a lanyard around your neck—keep the mobile device and its antenna at least 2.5 centimeters (1 inch) from your body when transmitting.

Using accessories not supplied or approved by Motorola may cause your mobile device to exceed RF energy exposure guidelines. For a list of Motorola-supplied or approved accessories, visit our website at: www.motorola.com.

RF Energy Interference/Compatibility

Nearly every electronic device is subject to RF energy interference from external sources if inadequately shielded, designed, or otherwise configured for RF energy compatibility. In some circumstances your mobile device may cause interference with other devices.

Follow Instructions to Avoid Interference Problems

- Turn off your mobile device in any location where posted notices instruct you to do so.
- In an aircraft, turn off your mobile device whenever instructed to do so by airline staff.

- If your mobile device offers an airplane mode or similar feature, consult airline staff about using it in flight.

Implantable Medical Devices

If you have an implantable medical device, such as a pacemaker or defibrillator, consult your physician before using this mobile device.

Persons with implantable medical devices should observe the following precautions:

- ALWAYS keep the mobile device more than 20 centimeters (8 inches) from the implantable medical device when the mobile device is turned ON.
- DO NOT carry the mobile device in the breast pocket.
- Use the ear opposite the implantable medical device to minimize the potential for interference.
- Turn OFF the mobile device immediately if you have any reason to suspect that interference is taking place.
- Read and follow the directions from the manufacturer of your implantable medical device. If you have any questions about using your mobile device with your implantable medical device, consult your healthcare provider.

Driving Precautions

The use of wireless phones while driving may cause distraction. Discontinue a call if you can't concentrate on driving.

Additionally, the use of wireless devices and their accessories may be prohibited or restricted in certain areas. Always obey the laws and regulations on the use of these products.

Responsible driving practices can be found in the "Smart Practices While Driving" section in this guide (or separate guide).

Operational Warnings

Obey all posted signs when using mobile devices in public areas.

Potentially Explosive Atmospheres

Areas with potentially explosive atmospheres are often, but not always, posted and can include fueling areas, such as below decks on boats, fuel or chemical transfer or storage facilities, or areas where the air contains chemicals or particles, such as grain dust, or metal powders.

When you are in such an area, turn off your mobile device, and do not remove, install, or charge batteries. In such areas, sparks can occur and cause an explosion or fire.

Knowing Radio Frequency Safety

The design of your phone complies with updated NCRP standards described below.

In 1991–92, the Institute of Electrical and Electronics Engineers (IEEE) and the American National Standards Institute (ANSI) joined in updating ANSI's 1982 standard for safety levels with respect to

human exposure to RF signals. More than 120 scientists, engineers and physicians from universities, government health agencies and industries developed this updated standard after reviewing the available body of research. In 1993, the Federal Communications Commission (FCC) adopted this updated standard in a regulation. In August 1996, the FCC adopted hybrid standard consisting of the existing ANSI/IEEE standard and the guidelines published by the National Council of Radiation Protection and Measurements (NCRP).

Body-Worn Operation

To maintain compliance with FCC RF exposure guidelines, if you wear a handset on your body, use the Motorola supplied or approved carrying case, holster or other body-worn accessory. If you do not use a body-worn accessory, ensure the antenna is at least 2.5 centimeters from your body when transmitting. Use of non-Motorola-approved accessories may violate FCC RF exposure guidelines.

Your Motorola phone is designed to comply with local regulatory requirements in your country concerning exposure of human beings to RF energy.

For more information about RF exposure, visit the FCC website at www.fcc.gov.

Portable Radio Product Operation and EME Exposure

- Your Motorola radio product is designed to comply with the following national and international standards and guidelines

regarding exposure of human beings to radio frequency electromagnetic energy (EME):

- United States Federal Communications Commission, Code of Federal Regulations; 47 CFR part 2 sub-part J.
- American National Standards Institute (ANSI) / Institute of Electrical and Electronics Engineers (IEEE). C95. 1-1992.
- Institute of Electrical and Electronics Engineers (IEEE). C95. 1-2005 Edition.¹
- International Commission on Non-Ionizing Radiation Protection (ICNIRP) 1998.
- Ministry of Health (Canada). Safety Code 6. Limits of Human Exposure to Radio frequency Electromagnetic Fields in the Frequency Range from 3 kHz to 300 GHz, 1999.
- Australian Communications Authority Radio communications (Electromagnetic Radiation - Human Exposure) Standard 2003.
- ANATEL, Brazil Regulatory Authority, Resolution 303 (July 2, 2002) "Regulation of the limitation of exposure to electrical, magnetic, and electromagnetic fields in the radio frequency range between 9 kHz and 300 GHz." "Attachment to Resolution 303 from July 2, 2002."

1.The information provided in this document supersedes the general safety information in user's guides published prior to May 1, 2006.

Specific Absorption Rate

Your MOTOROLA BRUTE wireless phone meets the governmental requirements for exposure to radio waves.

Your wireless phone is a radio transmitter and receiver. It is designed and manufactured to not exceed limits for exposure to radio frequency (RF) energy set by the Federal Communications Commission (FCC) of the U.S. Government and by the Canadian regulatory authorities. These limits are part of comprehensive guidelines and establish permitted levels of RF energy for the general population. The guidelines are based on standards that were developed by independent scientific organizations through periodic and thorough evaluation of scientific studies. The standards include a substantial safety margin designed for the safety of all persons, regardless of age or health, and to account for any variations in measurements.

The exposure standard for wireless mobile phones employs a unit of measurement known as the Specific Absorption Rate (SAR). The SAR limit set by the FCC and by the Canadian regulatory authorities is 1.6 watts per kilogram (W/kg), averaged over one gram of tissue. Tests for SAR are conducted using procedures accepted by the FCC and by Industry Canada with the phone transmitting at its highest certified power level in all tested frequencies. Although the SAR is determined at the highest certified power level, the actual SAR level of the phone while operating can be below the maximum value. This is because the phone is designed to operate at

multiple power levels so as to use only the power required to reach the network. In general, the closer you are to a wireless base station, the lower the power output.

Before a phone model is available for sale to the public in the U.S. and Canada, it must be tested and certified to the FCC and Industry Canada that it does not exceed the limit established by each government for safe exposure. The tests are performed in positions and locations (e.g., at the ear and worn on the body) submitted to the FCC and available for review by Industry Canada. The highest SAR value for this model phone when tested for use at the ear is 0.59 W/kg, and when worn on the body, as described in this user guide, is 0.86 W/kg. Body-worn measurements can differ, depending upon available accessories and regulatory requirements. The SAR information includes the Motorola testing protocol, assessment procedure, and measurement uncertainty range for this product.

While there may be differences between the SAR levels of various phones and at various positions, they meet the governmental requirements for safe exposure. Please note that improvements to this product model could cause differences in the SAR value for later products; in all cases, products are designed to be within the guidelines.

Additional information on SAR can be found on the Cellular Telecommunications & Internet Association (CTIA) website: www.phonefacts.net or the Canadian Wireless Telecommunications Association (CWTA) website: www.cwta.ca.

Owner's Record

The model number, regulatory number, and serial number are located on a nameplate inside the battery compartment. Record the serial number in the space provided below. This will be helpful if you need to contact us about your phone in the future.

Model: MOTOROLA BRUTE i680

Serial No.:

Online Product Registration:

<http://www.motorola.com/us/productregistration>

Product registration is an important step toward enjoying your new Motorola product. Registration permits us to contact you for product or software updates and allows you to subscribe to updates on new products or special promotions. Registration is not required for warranty coverage. Please retain your original dated sales receipt, as you may need to provide it for warranty validation in the future.

Thank you for choosing a Motorola product.

Patent and Trademark Information

MOTOROLA, the Stylized M Logo and all other trademarks indicated as such herein are trademarks of Motorola, Inc. ® Reg. U.S. Pat. & Tm. Off. ©2009 Motorola, Inc. All rights reserved.

Microsoft and Microsoft Internet Explorer are registered trademarks of Microsoft Corporation.

T9 is a trademark owned by Tegic Communications. T9® Text Input Patent and Trademark Information.

This product is covered by U.S. Pat. 5,818,437, U.S. Pat. 5,953,541, U.S. Pat. 6,011,554 and other patents pending.

Java and all other Java-based marks are trademarks or registered trademarks of Sun Microsystems, Inc. in the U.S. and other countries.

All other product names or services mentioned in this manual are the property of their respective trademark owners.

Software Copyright Notice

The Motorola products described in this manual may include copyrighted Motorola and third party software stored in semiconductor memories or other media. Laws in the United States and other countries preserve for Motorola and third party software providers certain exclusive rights for copyrighted software, such as the exclusive rights to distribute or reproduce the copyrighted software. Accordingly, any copyrighted software contained in the Motorola products may not be modified, reverse-engineered, distributed, or reproduced in any manner to the extent allowed by law. Furthermore, the purchase of the Motorola products shall not be deemed to grant either directly or by implication, estoppel, or otherwise, any license under the copyrights, patents, or patent applications of Motorola or any third party software provider, except for the normal, non-exclusive, royalty-free license to use that arises by operation of law in the sale of a product.

Open Source Software Information

For instructions on how to obtain a copy of any source code being made publicly available by Motorola related to software used in this Motorola mobile device you may send your request in writing to:

MOTOROLA, INC.
OSS Management
600 North US Hwy 45
Libertyville, IL 60048
USA

The Motorola website opensource.motorola.com also contains information regarding Motorola's use of open source.

Motorola has created the opensource.motorola.com to serve as a portal for interaction with the software community-at-large.

To view additional information regarding licenses, acknowledgments and required copyright notices for open source packages used in this Motorola mobile device, please press  > **Games and Apps** > **Open Source Notices**.

Privacy and Data Security

Motorola understands that privacy and data security are important to everyone. Because some features of your phone may affect your privacy or data security, please follow these recommendations to enhance protection of your information:

- **Monitor access:** Keep your phone with you and do not leave it where others may have unmonitored access. Lock your device's keypad where this feature is available.
- **Keep software up to date:** If Motorola or a software/application vendor releases a patch or software fix for your phone which updates the device's security, install it as soon as possible.
- **Erase before recycling:** Delete personal information or data from your phone prior to disposing of it or turning it in for recycling. For step-by-step instructions on how to delete all personal information from your device, please contact your local service provider.
- **Understanding AGPS:** In order to comply with emergency caller location requirements of the FCC, certain Motorola phones incorporate Assisted Global Positioning System (AGPS) technology. AGPS technology also can be used in non-emergency applications to track and monitor a user's location, for example, to provide driving directions. Users who prefer not to permit such tracking and monitoring should avoid using such applications.

If you have further questions regarding how use of your phone may impact your privacy or data security, please contact Motorola.

Smart Practices While Driving

*Drive Safe, Call Smart*SM

Check the laws and regulations on the use of mobile devices and their accessories in the areas where you drive. Always obey them. The use of these devices may be prohibited or restricted in certain areas. Contact www.motorola.com/callsmart for more information.

Your mobile device lets you communicate by voice and data—almost anywhere, anytime, wherever wireless service is available and safe conditions allow. When driving a car, driving is your first responsibility. If you choose to use your mobile device while driving, remember the following tips:

- Get to know your Motorola phone and its features such as speed dial and redial. If available, these features help you to place your call without taking your attention off the road.
- When available, use a hands-free device. If possible, add an additional layer of convenience to your phone with one of the many Motorola Original hands-free accessories available today.

- Position your phone within easy reach. Be able to access your phone without removing your eyes from the road. If you receive an incoming call at an inconvenient time, if possible, let your voice mail answer it for you.
- Let the person you are speaking with know you are driving; if necessary, suspend the call in heavy traffic or hazardous weather conditions. Rain, sleet, snow, ice, and even heavy traffic can be hazardous.
- Do not take notes or look up phone numbers while driving. Jotting down a “to do” list or going through your address book takes attention away from your primary responsibility, driving safely.
- Dial sensibly and assess the traffic; if possible, place calls when your car is not moving or before pulling into traffic. If you must make a call while moving, dial only a few numbers, check the road and your mirrors, then continue.
- Do not engage in stressful or emotional conversations that may be distracting. Make people you are talking with aware you are driving and suspend conversations that can divert your attention away from the road.
- Use your phone to call for help. Dial 911 or other local emergency number in the case of fire, traffic accident, or medical emergencies.*
- Use your phone to help others in emergencies. If you see an auto accident, crime in progress, or other serious emergency where lives are in danger, call 911 or other local emergency number, as you would want others to do for you.*
- Call roadside assistance or a special non-emergency wireless assistance number when necessary. If you see a broken-down vehicle posing no serious hazard, a broken traffic signal, a minor traffic accident where no one appears injured, or a vehicle you know to be stolen, call roadside assistance or other special non-emergency wireless number.*
 - * Wherever wireless phone service is available

S2. Manufacturer's Warranty

- ◆ Motorola Limited Warranty for the United States and Canada (page 172)
- ◆ Service and Repairs (page 176)

Your phone has been designed to provide you with reliable, worry-free service. If for any reason you have a problem with your equipment, please refer to the manufacturer's warranty in this section.

For information regarding the terms and conditions of service for your phone, please visit www.nextel.com or call Nextel Customer Service at **1-800-639-6111**.

Motorola Limited Warranty for the United States and Canada

What does this Warranty Cover?

Subject to the exclusions contained below, Motorola, Inc. warrants its telephones, pagers, messaging devices, and consumer and professional two-way radios (excluding commercial, government or industrial radios) that operate via Family Radio Service or General Mobile Radio Service, Motorola-branded or certified accessories sold for use with these Products ("Accessories") and Motorola software contained on CD-ROMs or other tangible media and sold for use with these Products ("Software") to be free from defects in materials and workmanship under normal consumer usage for the period(s) outlined below. This limited warranty is a consumer's exclusive remedy, and applies as follows to new Motorola Products, Accessories and Software purchased by consumers in the United States or Canada, which are accompanied by this written warranty:

Products and Accessories

Products Covered	Length of Coverage
Products and Accessories as defined above, unless otherwise provided for below.	One (1) year from the date of purchase by the first consumer purchaser of the product unless otherwise provided for below.
Decorative Accessories and Cases. Decorative covers, bezels, PhoneWrap™ covers and cases.	Limited lifetime warranty for the lifetime of ownership by the first consumer purchaser of the product.
Monaural Headsets. Ear buds and boom headsets that transmit mono sound through a wired connection.	Limited lifetime warranty for the lifetime of ownership by the first consumer purchaser of the product.
Consumer and Professional Two-Way Radio Accessories.	Ninety (90) days from the date of purchase by the first consumer purchaser of the product.

Products Covered	Length of Coverage
Products and Accessories that are Repaired or Replaced.	The balance of the original warranty or for ninety (90) days from the date returned to the consumer, whichever is longer.

Exclusions

Normal Wear and Tear. Periodic maintenance, repair and replacement of parts due to normal wear and tear are excluded from coverage.

Batteries. Only batteries whose fully charged capacity falls below 80% of their rated capacity and batteries that leak are covered by this limited warranty.

Abuse, Misuse and Accidents. Defects or damage that result from abuse, misuse or accidents, including but not limited to: (a) improper handling, usage, operation or storage (e.g. operating the Product outside its permitted or intended uses including as set forth by Motorola in the Products specification sheets or other documentation, or failing to comply with the Products usage documentation); abuse/neglect (e.g. broken/bent/missing clips/fasteners/connectors); (b) contact with liquids, water, rain, extreme humidity, heavy perspiration or other moisture, sand, food, dirt or similar substances caused from incorrectly securing the phone's protective elements or

subjecting the Products to conditions beyond their stated specification or limits; (c) use of the Products for commercial rental purposes; or (d) external causes or acts which are not the fault of Motorola, including but not limited to flood, fire, earthquake, tornado or other acts of God, are excluded from coverage.

Use of Non-Motorola Products and Accessories. Defects or damage that result from the use of Non-Motorola branded or certified Products, Accessories, Software or other peripheral equipment are excluded from coverage.

Unauthorized Service or Modification. Defects or damages resulting from service, testing, adjustment, installation, maintenance, alteration, or modification in any way by someone other than Motorola, or its authorized service centers, are excluded from coverage.

Altered Products. Products or Accessories with (a) serial numbers or date tags that have been removed, altered or obliterated; (b) broken seals or that show evidence of tampering; (c) mismatched board serial numbers; or (d) nonconforming or non-Motorola housings, or parts, are excluded from coverage.

Communication Services. Defects, damages, or the failure of Products, Accessories or Software due to any communication service or signal you may subscribe to or use with the Products Accessories or Software is excluded from coverage.

Software

Products Covered	Length of Coverage
Software. Applies only to physical defects in the media that embodies the copy of the software (e.g. CD-ROM, or floppy disk).	Ninety (90) days from the date of purchase.

Exclusions

Software Embodied in Physical Media. No warranty is made that the software will meet your requirements or will work in combination with any hardware or software applications provided by third parties, that the operation of the software products will be uninterrupted or error free, or that all defects in the software products will be corrected.

Software NOT Embodied in Physical Media. Software that is not embodied in physical media (e.g. software that is downloaded from the internet), is provided "as is" and without warranty.

Who Is Covered?

This warranty extends only to the first consumer purchaser, and is not transferable.

What Will Motorola Do?

Motorola, at its option, will at no charge repair, replace or refund the purchase price of any Products, Accessories or Software that does not conform to this warranty. We may use functionally equivalent reconditioned/refurbished/pre-owned or new Products, Accessories or parts. No data, software or applications added to your Product, Accessory or Software, including but not limited to personal contacts, games and ringer tones, will be reinstalled. To avoid losing such data, software and applications please create a back up prior to requesting service.

How to Obtain Warranty Service or Other Information

USA	Phones 1-800-453-0920
TTY	1-877-483-2840
For Accessories and Software, please call the telephone number designated above for the product with which they are used	

You will receive instructions on how to ship the Products, Accessories or Software, at your expense, to a Motorola Authorized Repair Center. To obtain service, you must include:

- (a) a copy of your receipt, bill of sale or other comparable proof of purchase;
- (b) a written description of the problem;
- (c) the name of your service provider, if applicable;
- (d) the name and location of the installation facility (if applicable) and, most importantly;
- (e) your address and telephone number.

What other limitations are there?

ANY IMPLIED WARRANTIES, INCLUDING WITHOUT LIMITATION THE IMPLIED WARRANTIES OF MERCHANTABILITY AND FITNESS FOR A PARTICULAR PURPOSE, SHALL BE LIMITED TO THE DURATION OF THIS LIMITED WARRANTY, OTHERWISE THE REPAIR, REPLACEMENT, OR REFUND AS PROVIDED UNDER THIS EXPRESS LIMITED WARRANTY IS THE EXCLUSIVE REMEDY OF THE CONSUMER, AND IS PROVIDED IN LIEU OF ALL OTHER WARRANTIES, EXPRESS OR IMPLIED. IN NO EVENT SHALL MOTOROLA BE LIABLE, WHETHER IN CONTRACT OR TORT (INCLUDING NEGLIGENCE) FOR DAMAGES IN EXCESS OF THE PURCHASE PRICE OF THE PRODUCT, ACCESSORY OR SOFTWARE, OR FOR ANY INDIRECT, INCIDENTAL, SPECIAL OR CONSEQUENTIAL DAMAGES OF ANY KIND, OR LOSS OF REVENUE OR PROFITS, LOSS OF BUSINESS, LOSS OF INFORMATION OR DATA, SOFTWARE OR APPLICATIONS OR OTHER FINANCIAL LOSS ARISING OUT OF OR IN CONNECTION WITH THE ABILITY OR INABILITY TO USE THE PRODUCTS, ACCESSORIES OR SOFTWARE TO THE FULL EXTENT THESE DAMAGES MAY BE DISCLAIMED BY LAW.

Some states and jurisdictions do not allow the limitation or exclusion of incidental or consequential damages, or limitation on the length of an implied warranty, so the above limitations or exclusions may not apply to you. This warranty gives you specific legal rights, and you may also have other rights that vary from state to state or from one jurisdiction to another.

Laws in the United States and other countries preserve for Motorola certain exclusive rights for copyrighted Motorola software such as the exclusive rights to reproduce and distribute copies of the Motorola software. Motorola software may only be copied into, used in, and redistributed with, the Products associated with such Motorola software. No other use, including without limitation disassembly of such Motorola software or exercise of the exclusive rights reserved for Motorola, is permitted.

Service and Repairs

If you have questions or need assistance, we're here to help.

Go to www.motorola.com/support, where you can select from a number of customer care options. You can also contact the Motorola Customer Support Center at 1-800-453-0920 (United States), 1-877-483-2840 (TTY/TDD United States for hearing impaired).

Index

A

- Accessories 20
 - Charger 20
 - Li-Ion Battery 20
- Activation 2
- Airplane Mode 77
- Answering Calls 22
- Applications
 - See also Java Applications
- Attachments 57
 - See also MMS Messages
- Audio Files
 - Fast Forward and Rewind 144
 - Inserting in Messages 55
 - Pause 144
 - Playing 143
 - Resume 144
 - See also Voice Records
 - Skip 144

Volume 144

B

- Backlight 73
- Battery 9–11
 - Charging 11
 - Disposal 160
 - Installing 10
 - Safety 158
- Bluetooth 132–137
 - Deleting Received Items 137
 - Receiving Items 136
 - Sending Contacts 135
 - Transfers, Canceling 136
 - Viewing Received Items 136
- Bookmarks
 - Accessing 67
 - Creating 67
- Browser
 - Opening 66
 - Restarting 68

C

- Calendar
 - See Datebook
- Call Alerts
 - Answer 41
 - Deleting 42
 - Queue 42
 - Responding 42
 - Sending 41
 - Viewing 42
- Call Filtering 81
- Call Forwarding 61, 62
 - All Calls 62
 - Missed Calls 63
 - Off 62
- Call Timers 120
- Call Waiting 60
 - Off 60
- Caller ID 59
- Calls
 - Direct Connect Calls 28
 - Direct Talk Calls 43

- From Contacts 29
- Group Connect 30
- International 64
- Phone Call While in Direct
 - Connect 27
- Phone Calls 22
- Talkgroup Calls 39
- Using the Member ID 29
- Voice Name 27, 30
- Camcorder
 - See Video
- Camera 126–128
 - Camera Setup 128
 - Exposure Control 127
 - GPS Tag 127, 128
 - Options 127
 - Self Timer 127
 - Style 127
 - Talking Pictures 126
 - White Balance 127
 - Zoom 128
- Carousel 84
- Clock Display 74

- Contacts 97–103
 - Adding an Entry 98
 - Assign a Picture to an Entry 103
 - Creating 98
 - Deleting 102
 - Editing Entries 101
 - Making Direct Connect Calls 29
 - Making Phone Calls 27
 - Searching 100
 - Voice Name 99

D

- Datebook
 - Creating Events 105
 - Deleting Events 107
 - Editing Events 107
 - Making Calls From Datebook and Datebook Reminders 108
 - Receiving Reminders 107
 - Using Your Phone's Datebook 104

- Dialing Codes
 - Non-Emergency Numbers 64
 - Telecommunications Relay Service 64
- Digital Rights Management See DRM
- Direct Connect
 - One Touch, Setting 78
- Direct Connect Calls
 - Dialing 28
 - From Contacts 29
 - Member ID 29
 - Voice Name 30
- Direct Connect Number
 - Viewing 16, 109
- Direct Connect Numbers 29
- Direct Send 34–39
 - Contacts 38
 - Groups 39
 - My Info 37
 - Pictures 34
 - Receiving Contacts 38

- Receiving My Info 38
- Receiving Pictures 35
- Direct Talk
 - Code 44
 - Private Only 45
 - Receiving All Calls On Channel 46
 - Setting Up 44
- Display Screen 13
- Downloading Content 68
- DRM 111
 - Deleting Items 141
 - Expired Items 113
 - Managing Items 112
 - Renewing Items 112
 - Renewing License 112
 - Status Icons 140
 - Viewing License Information 112

E

- Email 66
- Emergency Numbers 23
- End-of-Call Options 25

- Entering Text 16–19
 - Alpha Mode 17
 - Numbers 18
 - Quick Notes 18
 - Selecting Mode 16
 - Word Text Input 16

F

- Fast Forward
 - Music 144

G

- Games 68
 - See also Java Applications
- GPS Enabled 113
 - Best Results 115
 - Emergency Calls 114
 - Map Software 116
 - Privacy Options 86
 - Security 87
 - Viewing Location 114
- GPS PIN 87
- Group Connect
 - Adding Group Members 31

- Creating Groups 31
- Deleting 32
- Groups vs. Talkgroups 39
- Icons 34
- Making Calls 30
- Removing Members 32
- Sending With Direct Send 39
- Settings 88

H

- Headset 78
- Hearing Aid Compatibility 161

I

- Icons
 - Contacts 98
 - Groups 34
 - Status Information 13
- Images
 - Editing 150, 151
 - Menu 150
 - Slideshow 150
 - Viewing 150
- In-Call Options 24
- International Numbers 64

J

- Java Applications 110–111
 - Deleting 111
 - Downloading 111
 - Downloading Games 68
 - Ending Applications 110
 - Installing Applications 110
 - Memory 112
 - Privacy 88
 - Resuming Applications 110
 - Running Applications 110
 - Suspending Applications 110

K

- Key Functions 6

L

- Language 85
- Lock Code
 - Changing 91
- Locking Your Keypad 91
- Locking Your Phone 90

M

- Making Calls 22

- Media Center 138
 - Deleting 140
 - Forward Locked 139
 - Locking Items 140
 - Memory 141
 - Pictures 141
 - Renaming Items 140
 - Viewing 138

Memo 117

- Calling From 118
- Editing 117
- Viewing 117

Memory

- Java Applications 112
- Media Center 141
- MMS Messages 75
- Ring Tones 70
- Voice Records 120

Menu

- Navigation 14
- Selecting 15

Menu Style 74

- Message Center 47
 - MMS Messages 50
 - Text Messaging (SMS) 59
 - Voicemail 49

Messages

- Notifications 48

Messaging Settings

- Notification 75
- Signature 77

microSD Card 121–125

- Adapter 123
- Folders 124
- Formatting 124
- Inserting 121
- Memory 123
- Removing 122
- Setting Storage Options 124

MMS Messages 50–59

- Attachments 57
- Calls From 58
- CleanUp 77
- Deleting 57
- Embedded Objects 57

- Forwarding 56, 57
- Going to Website 59
- Locking 58
- Memory 75
- Outbox 56
- Quick Notes 54
- Receiving 56
- Sending 50
- Multimedia 138–149
- Multimedia Messages
 - See MMS Messages
- Music
 - Fast Forward and Rewind 144
 - Pause and Resume 144
 - Playing 143
 - Volume 144
- Mute 25
- My Info
 - Editing 109
 - Receiving 38, 93
 - Sending 36

- My Music
 - Accessing 142
 - Deleting Files 148
 - Equalizer 149
 - Folders and Lists 143
 - Playlists 146
 - Repeat 145
 - Visuals 149

N

- Nextel Direct Send
 - See Direct Send
- Nextel Direct Talk
 - See Direct Talk
- Nextel Service
 - Account Passwords 3
 - Activation 2
 - Operator Services 4
- Non-Emergency Numbers 64
- Notepad
 - See Memo

O

- One Touch Direct Connect 78
- Outbox 56
- Owner's Record 168

P

- Pauses 26
 - Storing 100
- Phone
 - Connecting to Computer 125
- Phone (illus.) 5
- Phone Number
 - Finding 26
 - Saving 25
 - With Pauses 26
 - Your Numbers 16
- Phone Settings 69–90
 - Call Answer Mode 84
 - Display Settings 73–75
 - Language 85
 - Messaging Settings 75–77
 - Shortcuts 82
 - Sound Settings 69–73

- Pictures 141
 - Inserting in Messages 54, 141
 - Saving From Messages 59
- Playlist 146
 - Creating 146
 - Editing 146
 - Favorites 147
 - Reordering 146
- Podcasts 148
- Prepend Dialing 85
- Profiles 78
 - Call Filtering 81
 - Creating 80
 - Deleting 80
 - Editing 80
 - Switching 79
 - Temporary 79
 - Viewing 78
- PTT Options 88
- Push To Talk 88

Q

- Quick Notes 54

R

- Radio Frequency 164
- Recent Calls 92–95
 - Call Alerts 93
 - Deleting Recent Calls List 95
 - My Info 93
 - Prepending a Number 96
 - Saving a Number 95
- Remote Direct Connect Button 20
- Resetting Your Phone 85
- Rewind
 - Music 144
- Ring Tones
 - Deleting 70
 - Memory 70
 - Setting in Contacts 99
 - Vibrate 72
- Ringer Types 69

S

- Safety Information 154–171
 - Radio Frequency 164
 - Tips 155
- Security 89–91
- Shortcuts
 - Creating 82
 - Deleting 83
 - Editing 83
 - Using 82
- Silence All 72
- SIM Card
 - Removing and Inserting 8
 - Security 89
- SIM PIN 89
- Songs
 - See Music Player
- Speakerphone 25
- Speed Dial
 - Assigning Numbers 102
 - Making a Call 27

T

- Talkgroups 39
 - Join 40
 - Settings 88
- TDD/TTY Devices 64
- Telecommunications Relay
 - Service 64
- Text Entry 16–19
 - Database 17
 - Mode 16
- Text Messaging
 - See MMS Messages
- Three-Way Calling 61
- Transmitters
 - Turning On and Off 77
- TTY Devices 64
- Turning Your Phone On and Off 12

U

- Unlocking Your Keypad 91
- Unlocking Your Phone 91

V

- Vibrate All 71
- Video 128
 - My Videos 151
 - Options 129
 - Recording 128
 - Settings 129
 - Viewing 151
- Voice Name 27, 30
 - Creating 99
- Voice Records
 - Creating 118
 - Deleting 119
 - Inserting in Messages 55
 - Labelling 119
 - Locking 119
 - Memory 120
 - Playing 119
 - Saving From Messages 59
- Vicemail
 - Playing Messages 49
 - Retrieving 48
 - Setting Up 2, 49

Volume

- Music 144

W

- Waits
 - Storing 100
- Wallpaper 73, 142
- Warranty 172–176
- Water Resistance 12
- Web 66–68
 - Bookmarks 67
 - Go to Websites 67
 - Launching 66
 - Reloading a Web Page 68
 - Restarting 68
- Wireless Data Services 66
 - Downloads 68
 - Games, Ringers, & More 68
- Word Text Input 16